



Westinghouse

USER'S MANUAL
MANUEL DE L'UTILISATEUR
MANUAL DEL USUARIO

SK-26H570D
SK-32H570D

Widescreen DVD Combo

Combo Lecteur à Écran Géant

Combo DVD Pantalla Grande



www.wde.com

TABLE OF CONTENTS

IMPORTANT INFORMATION	2
1. WARNING	2
2. SAFETY GUIDELINES	3
3. IMPORTANT SAFETY INSTRUCTIONS	4
4. ANTENNA INSTALLATION SAFETY	6
5. CLEANING THE LCD TV	6
6. DISC USAGE	7
SYSTEM TOUR	9
1. PACKAGE CONTENTS	9
2. TV CONTROLS	10
3. TERMINALS	11
4. REMOTE CONTROL	12
INSTALLATION	14
1. LCD TV BASE	14
2. REMOTE CONTROL BATTERIES	16
3. ANTENNA CONNECTION	17
4. EXTERNAL DEVICE CONNECTIONS	19
5. POWER CONNECTION	21
6. INITIAL SETUP	21
BASIC OPERATION	22
1. TURNING THE POWER ON AND OFF	22
2. ADJUSTING THE VOLUME	22
3. CHANGING CHANNELS	23
4. SELECTING THE INPUT SOURCE	24
5. ADJUSTING THE DISPLAY FORMAT	24
SETUP MENUS	25
1. SETUP MENU OPERATION	25
2. MENU SETTING SCREENS	26
DVD PLAYER	54
1. PLAYING MULTIMEDIA FILES	54
2. MULTIMEDIA MODES	55
3. FILE PLAYBACK CONTROLS	56
4. DVD SETUP MENUS	57
5. MP3/WMA/JPEG CD INFORMATION	58
SPECIFICATIONS	60
TROUBLESHOOTING	62
APPENDIX A - LCD TV BASE REMOVAL	63
APPENDIX B - SAFETY BRACKETS	64
1. ANTI-TIPPING MECHANISM	64
2. ANTI-THEFT PROTECTION	64
APPENDIX C - WALL MOUNT OPTION	65

IMPORTANT INFORMATION

1. WARNING

WARNING : TO REDUCE THE RISK OF FIRE OR ELECTRIC SHOCK, DO NOT EXPOSE THIS PRODUCT TO RAIN OR MOISTURE.



CAUTION
RISK OF ELECTRIC SHOCK
DO NOT OPEN



CAUTION: TO REDUCE THE RISK OF ELECTRIC SHOCK, DO NOT REMOVE COVER (OR BACK). NO USER-SERVICEABLE PARTS INSIDE. REFER SERVICING TO QUALIFIED SERVICE PERSONNEL.



The lightning flash with arrow-head symbol, within an equilateral triangle, is intended to alert the user to the presence of uncontrolled "dangerous voltage" within the product's enclosure that may be of sufficient magnitude to constitute a risk of electric shock to persons.



The exclamation point within a triangle is intended to alert the user to the presence of important operating and maintenance (servicing) instructions in the literature accompanying the product.

IMPORTANT INFORMATION

2. SAFETY GUIDELINES

WARNING: *This device must be operated with the original power supply.*

CAUTION: *The power supply outlet should be located near the LCD TV and should be easily accessible. Always use the appropriate AC cord that is certified for your specific country. Some examples are listed below:*

USA.....UL
Japan Electric Appliance Control Act
Canada.....CSA

IMPORTANT NOTICES CONCERNING POWER CORD SELECTION

The specific power cord for this LCD TV is enclosed and has been selected according to the country of destination. Use the enclosed power cord to prevent electric shock. Observe the following guidelines if it is necessary to replace the original cord set, or if there is no cord set enclosed. The female receptacle of the cord set must meet IEC-60320 requirements and should look like Figure A1 below:



For the United States and Canada

In the United States and Canada the male plug is a NEMA5-15 style (Figure A2), UL-listed, and CSA-labeled. For LCD TVs that are to be placed on a desk or table, type SVT or SJT cord sets may be used. For LCD TVs that are to be placed directly on the floor, only SJT type cord sets may be used. The cord set must be selected according to the current rating for the LCD TV. Consult the table below for the selection criteria of power cords used in the United States and Canada.

Cord Type	Size of Conductors in Cord	Maximum Current Rating of Unit
SJT	18 AWG	10 Amps
	16 AWG	12 Amps
	14 AWG	12 Amps
SVT	18 AWG	10 Amps
	17 AWG	12 Amps

FCC COMPLIANCE STATEMENT

This equipment has been tested and complies with the limits for a Class B digital device, pursuant to part 15 of the FCC Rules. These limits are designed to provide reasonable protection against harmful interference in a residential installation. This equipment generates, uses, and can radiate radio frequency energy, and may cause harmful interference to radio communications if not installed and used in accordance with the instructions. However, there is no guarantee that interference will not occur in a particular installation. If this equipment does cause harmful interference to radio or television reception, which can be determined by turning the equipment off and on, the user is encouraged to try to correct the interference by one or more of the following measures:

- Reorient or relocate the receiving antenna.
- Increase the distance between the LCD TV and the receiver.
- Connect the LCD TV to an outlet on a circuit separate from to which the receiver is connected.
- If the interference persists even after performing the above measures, consult the Westinghouse Service Center or an experienced radio/TV technician for assistance.

FCC Warning

To assure continued FCC compliance, use a grounded power supply cord and the provided shielded video interface cable with bonded ferrite cores. If a BNC cable is used, use only a shielded BNC (5) cable. Also, any unauthorized changes or modifications not expressly approved by manufacturer will void the user's authority to operate this device.

IMPORTANT INFORMATION

3. IMPORTANT SAFETY INSTRUCTIONS

Make sure to note and follow all warnings and instructions marked on the LCD TV. Observe the following safety instructions.

- Read and understand all the safety and operating instructions in this manual before you use the LCD TV.
- Keep this user manual for future reference.
- Do not use the LCD TV near water.
- Avoid exposing the LCD TV to moisture or high humidity.
- Do not install near any heat sources such as radiators, heat registers, stoves, or other apparatus (including amplifiers) that produce heat.
- Avoid exposing the LCD TV to direct sunlight or high temperatures.
- Do not install near a motor or transformer where strong magnetism is generated.
- Do not attempt to bypass the safety purpose of the polarized or grounding-type plug. A polarized plug has two blades with one wider than the other. A grounding-type plug has two blades and a third grounding prong. If the provided plug does not fit into your wall outlet, consult an electrician for replacement of the obsolete outlet.
- Protect the power cord from being walked on or pinched particularly at the ends of the cord.
- Only use attachments and accessories specified by the manufacturer.
- Use only with a cart, stand, tripod, bracket, or table specified by the manufacturer, or sold with the LCD TV. When a cart is used, use caution when moving the cart to avoid injury or damage.



- Unplug the LCD TV during lightning storms or when it will not be used for a long period of time.
- Refer all servicing to qualified service personnel. Do not attempt repairs yourself. The product warranty does not cover repairs or attempted repairs by anyone not authorized by the manufacturer. Servicing is required when:
 - the LCD TV has been dropped, or otherwise damaged in any way.
 - liquid has been spilled into or objects have fallen onto the LCD TV.
 - the LCD TV has been exposed to rain or moisture and does not operate normally
- DISC SLOT – Keep your fingers off the disc slot when loading a disc to prevent any physical injury.
- LASER BEAM – Do not direct your vision on the drive laser beam, either by looking directly into the disc slot or through the chassis openings.
- DISC – Do not use a cracked, deformed, or repaired disc. These discs are easily broken and may cause serious physical injury and/or product damage.

Circuit Overload

Do not overload wall outlets, extension cords, or power strips. This can result in a fire or electronic shock.

Power Cord Protection

Power supply cords should be routed so that they are not likely to be walked on or pinched by items placed upon or against them. Periodically inspect the cords for damage. Install the LCD TV near a wall socket outlet where the power cord can be readily access.

Ventilation

The slots and openings on the cabinet are provided for necessary ventilation. To ensure reliable operation of the LCD TV and to protect it from overheating, these slots and openings must never be blocked or covered.

IMPORTANT INFORMATION



Never cover the slots and openings with a cloth or other materials.



Do not block the openings by placing the LCD TV on a bed, sofa, rug or other similar surface.



Do not place the LCD TV in a built-in installation such as a bookcase or a rack unless proper ventilation is provided or the manufacturer's instruction have been adhered to.

Warnings and Precautions

- Do not orient the LCD TV towards direct sunlight to reduce glare.
- If the LCD TV will not be used for a long period of time, unplug the unit and remove the batteries from the remote control.
- Avoid touching the display screen by hand or any object.
- Never remove the rear cover. The LCD TV interior contains high-voltage parts. You may be seriously injured if you touch them.
- Always handle the LCD TV with caution when moving it.
- Do not install the LCD TV in airtight compartments, or in areas where it can be exposed to water or high temperature.
- Ensure that the area around the LCD TV is clean and free of moisture.
- Do not place anything on the LCD TV that can hinder heat dissipation.
- Do not place anything on the LCD TV that can cause liquid to splash on it (e.g. flower vase).
- Do not place heavy objects on the LCD TV, audio/video cables, or power cord.
- If the LCD TV emits smoke, abnormal noise, or a strange odor, immediately turn it off and contact the Westinghouse Service Center by:
 - logging on to www.wde.com
 - contacting the Westinghouse Customer Service at (866) 287-5555.
 - e-mailing us at service@wde.com

IMPORTANT INFORMATION

4. ANTENNA INSTALLATION SAFETY

Outdoor Antenna Grounding

If an outside antenna or cable system is connected to the LCD TV, be sure the antenna or cable system is grounded to prevent voltage surges and built-up static charges. Article 810 of the National Electrical Code, ANS/NFPA 70, provides information on proper grounding of the mast and supporting structure, grounding of the lead-in wire to an antenna discharge unit, connection to grounding electrodes, and requirements for the grounding electrode.

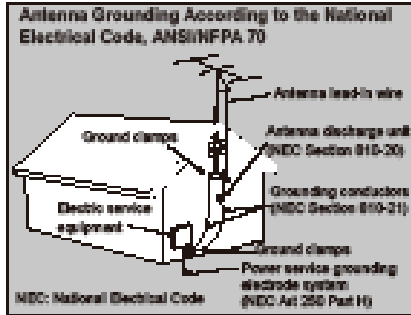

Lightning



For added protection for the LCD TV during a lightning storm, or when it is left unattended and unused for long periods of time, unplug it from the wall outlet and disconnect the antenna or cable system. DO NOT disconnect the antenna or the power cord during a heavy storm—lightning may strike while you are holding the cable cord, causing serious injury. Turn off the LCD TV and wait for the weather to improve.

Power Lines

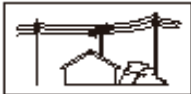

An outside antenna system should not be located in the vicinity of overhead power lines or other electric light or power circuits, or where it can fall into such power lines or circuits. When installing an outside antenna system, extreme care should be taken to keep from touching such power lines or circuits as contact with them might be fatal.

5. CLEANING THE LCD TV



- MAKE SURE THE LCD TV IS TURNED OFF AND THE POWER CORD IS DISCONNECTED FROM THE POWER OUTLET.
- NEVER SPRAY OR POUR ANY LIQUID DIRECTLY ONTO THE SCREEN OR THE CASE.

To clean the screen:

- (1) Wipe the screen with a clean, soft, lint-free cloth. This removes dust and other particles.
- (2) If it still is not clean, apply a small amount of non-ammonia, non-alcohol based glass cleaner onto a clean, soft, lint-free cloth, and wipe the screen.

To clean the case:

- (1) Wipe the case with a soft, dry cloth.
- (2) If it still is not clean, apply a small amount of non-ammonia, non-alcohol based, mild non-abrasive detergent onto a clean, soft, lint-free cloth, then wipe the surface.

6. DISC USAGE

To handle discs:

- Hold the disc by its edges. Do not touch the surface of the disc.
- Do not attach paper labels or stickers to the disc.

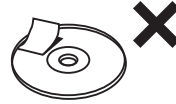
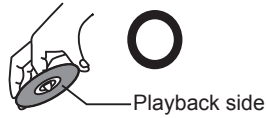

To clean discs:

- Wipe the disc with a clean, dry cloth from the center outward toward the edges.
- Do not wipe the disc in a circular motion.
- Do not use liquid or aerosol cleaners.

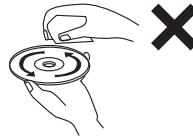

To store discs:

- Store the disc in the case to avoid any risk of scratches, dirt or damage.
- Do not leave the disc exposed to direct sunlight or store it in hot or humid places.

► NOTES:

- Playback for non-standard discs is not guaranteed. If such discs are played, the image or sound quality may be poor.
- Only standard music CDs that does not have copy-restriction signals can be played in this unit.
- Playback for CD-R/RW and DVD-R/RW discs depends on the recording conditions.
- For a complete list of supported disc and file formats, go to page 59.

IMPORTANT INFORMATION

Region Management Information

This unit supports DVDs with a region code of 1 or ALL. Some DVDs that have no region code label may still be subject to area restrictions and therefore not playable.

Disc Contents Structure

Normally, DVDs are divided into titles, and the titles are sub-divided into chapters.

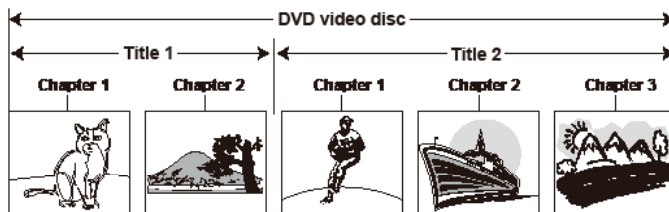

Video CDs and audio CDs are divided into tracks.



Each title, chapter or track is assigned a number, which is called "title number", "chapter number" or "track number" respectively.

Notes on Copyright

The unauthorized recording, use, distribution, or revision of copyrighted materials including, without limitation, television programs, videotapes, and DVDs, is prohibited under the Copyright Laws of the United States and other countries, and may subject the perpetrator to civil and criminal liability.









Dolby-Digital Notice

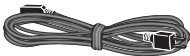

Manufactured under license from Dolby Laboratories. Dolby and the double-D symbol are registered trademarks of Dolby Laboratories.

Fabriqué sous licence de Dolby Laboratories. Dolby et le symbole du double D sont des marques de commerces de Dolby Laboratories.

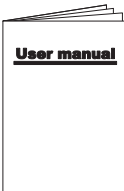
1. PACKAGE CONTENTS

<p>26"/32" LCD TV/DVD Unit</p> 	<p>Remote Control (with 2x AAA batteries)</p> 
<p>LCD TV/DVD Base</p> 	<p>Base Screws (4x) and Screwdriver (1x)</p> 
<p>Power Cord</p> 	<p>Quick Connect Guide</p> 
<p>User Manual</p> 	<p>Warranty Card</p> 

SYSTEM TOUR

2. TV CONTROLS

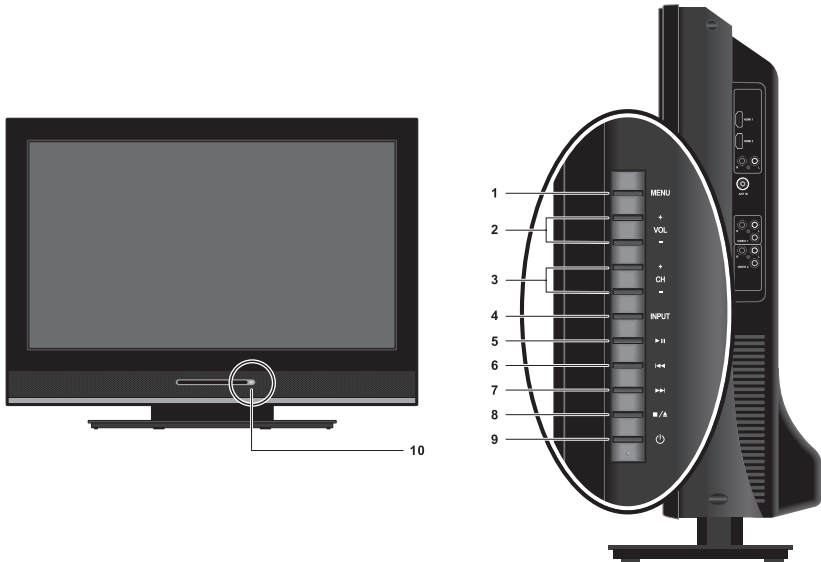

1. MENU	Display the LCD TV setup screen.
2. VOL + / -	During playback, adjust the volume. In a menu screen, select an item.
3. CH + / -	During TV viewing, adjust the channel. In a menu screen, select an item.
4. INPUT	Select the video source. In a menu screen, select an item.
5. Play/Pause	Press to play or pause playback.
6. Fast Rewind	Press once for fast rewind; press and hold to go to the previous chapter, track or picture.
7. Fast Forward	Press once for fast forward; press and hold to go to the next chapter, track or picture.
8. Stop/Play	<ul style="list-style-type: none"> • Press once to stop playback (the current playback position is saved). • Press twice or more to stop and return to the DVD root menu (if one is available) • Press and hold for two seconds to eject the disc.
9. Power	Toggles the power on and off.
10. Eject	Eject the disc from the disc slot.

3. TERMINALS

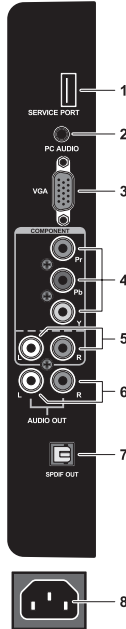
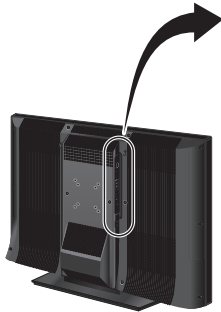

- | |
|---|
| 1. Service
For service/maintenance purposes only. |
| 2. PC Audio Input
Connect to the audio out port (green) of a computer. |
| 3. VGA
Using a 15-pin VGA cable, connect to a computer or other device with a VGA output. |
| 4. YPbPr Input
Connect an external video device with component output to these jacks. |
| 5. YPbPr Audio Input (Left/Right)
Connect an external audio source to these jacks. |
| 6. Analog Audio Output (Right/Left)
Connect this output to an external analog audio receiver. |
| 7. SPDIF Audio Output
Connect this output to an external digital audio receiver. |
| 8. AC In
Connect the power cord from this outlet to a power source. |

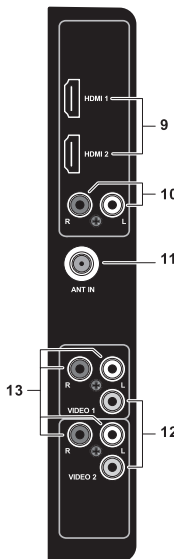





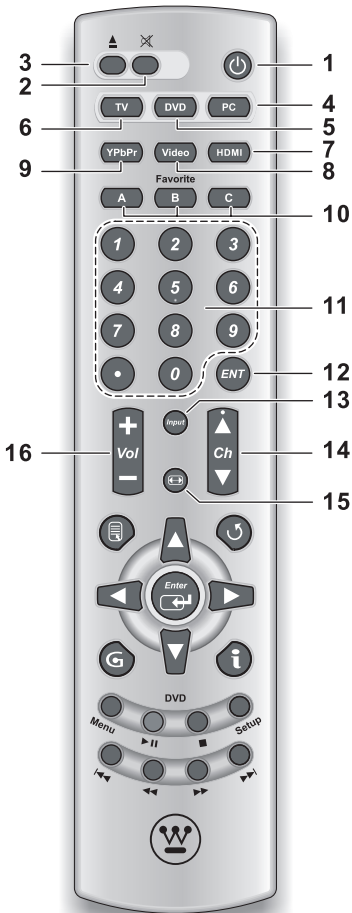

- | |
|---|
| 9. HDMI 1/2
Connect to an external video device such as a DVD player, game system, cable, or satellite box. |
| 10. HDMI Audio Input (Right/Left)
Connect an external audio source to these jacks. |
| 11. TV Tuner
Connect the LCD TV to an antenna or cable service. Supports NTSC, ATSC, and cable formats. |
| 12. Composite Video Input 1/2
Connect to an external video device with an analog signal such as a VCR. |
| 13. Composite Audio Output 1/2 (Right/Left)
Connect this output to an external audio receiver. |

SYSTEM TOUR

4. REMOTE CONTROL

English









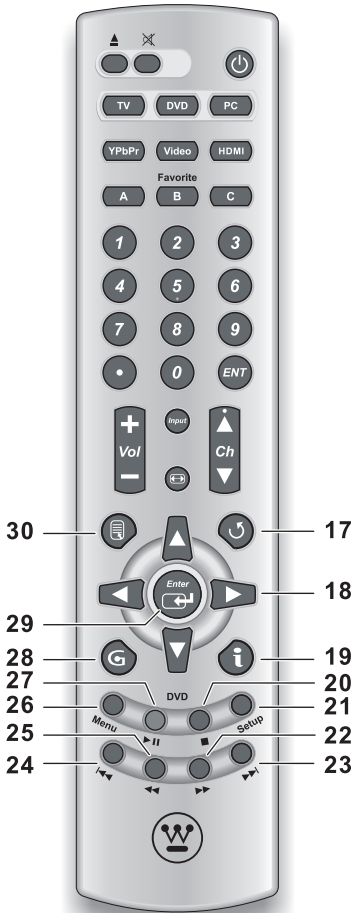





1. Power 	Toggle the TV power on and off.
2. Mute 	Mute the sound. Press it again to toggle the sound back on.
3. Eject 	Eject the disc from the disc slot.
4. PC	Enable VGA as the input source.
5. DVD	Enable DVD as the input source.
6. TV	Enable TV or HDTV as the input source.
7. HDMI	Enable HDMI 1 or HDMI 2 as the input source.
8. Video	Enable Composite 1 or Composite 2 as the input source.
9. YPbPr	Enable YPbPr as the input source.
10. Favorite	Switch to a previously bookmarked channel. Go to page 22 for details on how to save a new favorite channel.
11. Channel keys	Key in the channel number. Go to page 22 for instructions on how to change channels using these keys.
12. Enter <i>ENT</i>	Execute a channel entry.
13. Input	Select the video input source. Go to page 22 for instructions on how to use this key.
14. Ch  	Change the current TV channel.
15. Aspect Ratio 	Select the video display format. Options include Standard, Fill, and Overscan. Go to page 23 for a description of these options.
16. Vol +/-	Adjust the system volume.

► **NOTE:**

Make sure there are available channels first before setting up a favorite channel. If no channels are available, perform a channel scan. Go to page 20 for related instructions.



17. Return 	Switch to the previous channel.
18. Arrow keys 	Navigate through the on-screen menu selections.
19. Info 	Display the input source or channel information.
20. Stop 	Stop playback.
21. Setup	Display the DVD setup menu. Go to page 56 for more information.
22. Fast forward 	Scan the video playback forward.
23. Skip forward 	Skip to the next chapter, track or picture.
24. Skip reverse 	Skip to the previous chapter, track or picture.
25. Fast reverse 	Scan the video playback backward.
26. DVD menu	Display the DVD root menu (if available). Press it again to close the menu.
27. Play/Pause 	Press to play or pause playback.
28. Guide 	Display the electronic program guide (EPG). EPG availability depends on your digital TV provider
29. Enter 	Execute a command.
30. Menu 	Display the LCD TV setup screen.

INSTALLATION

1. LCD TV BASE

- (1) Open the LCD TV carton box.
- (2) Remove the LCD TV base from the carton box.
- (3) Remove the two top carton stabilizers from the LCD TV.
- (4) Remove the protective plastic covering the LCD TV.
- (5) Grasp the two sides of the LCD TV and then pull it out of the carton box.
- (6) Remove the two bottom carton stabilizers from the LCD TV.

CAUTION:

The LCD TV unit may be too heavy for one person to lift. If this is the case, make sure to ask assistance in handling the LCD TV to prevent physical injury and/or damage to the unit.

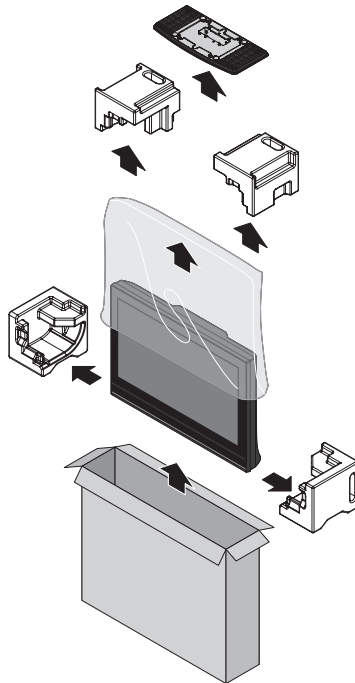

- (7) Lay the LCD TV on a clear, flat, and stable surface.
- (8) Remove the plastic bag containing the LCD TV base screws and screwdriver from the LCD TV base.

(9) Align the base to the bottom side of the LCD TV.

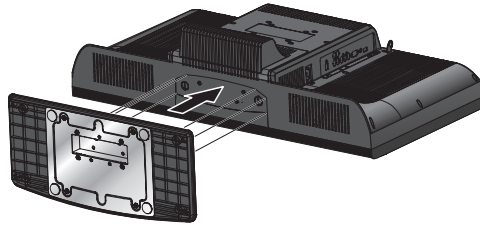

(10) Secure the base to the LCD TV with the four bundled screws.

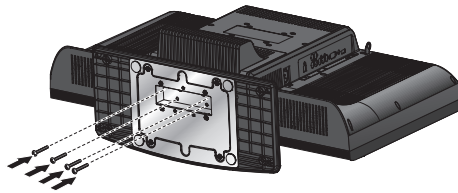

(11) Carefully orient the LCD TV in an upright position.

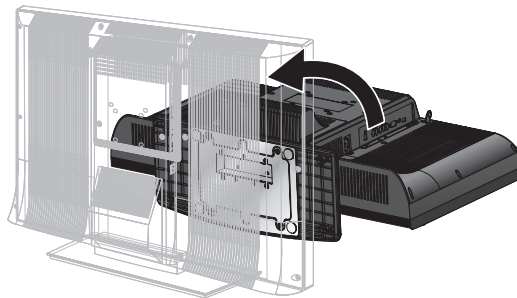

INSTALLATION

2. REMOTE CONTROL BATTERIES

- (1) Remove the battery cover.
- (2) Insert the batteries. Make sure the (+) and (-) marks on the batteries match those inside the compartment.
- (3) Re-attach the battery cover.

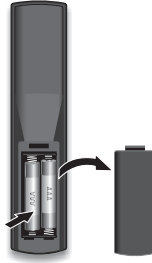

CAUTION:

- (1) Only use AAA batteries.
- (2) Do not mix new and old batteries. This may result in cracking or leakage, which may pose a fire risk or lead to personal injury.
- (3) Insert batteries according to the (+) and (-) markings. Inserting the batteries incorrectly may result in cracking or leakage, which may pose a fire risk or lead to physical injury.
- (4) Dispose of used batteries in accordance with local laws and regulations.
- (5) Keep batteries away from children and pets.
- (6) When the remote control will not to be used for an extended period, remove the batteries.

Remote Control Transmission Range

Transmission range depends upon the reception angle. The range of coverage is 20° horizontal/vertical at a distance of 20 feet from the LCD TV.

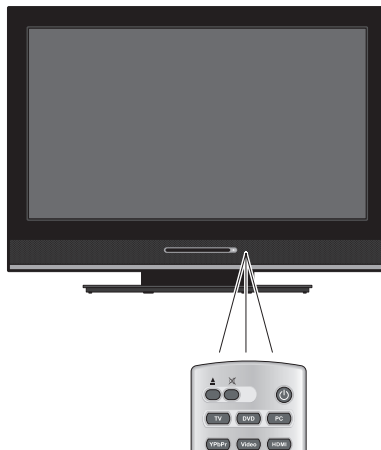

3. ANTENNA CONNECTION

Outdoor Antenna Connection

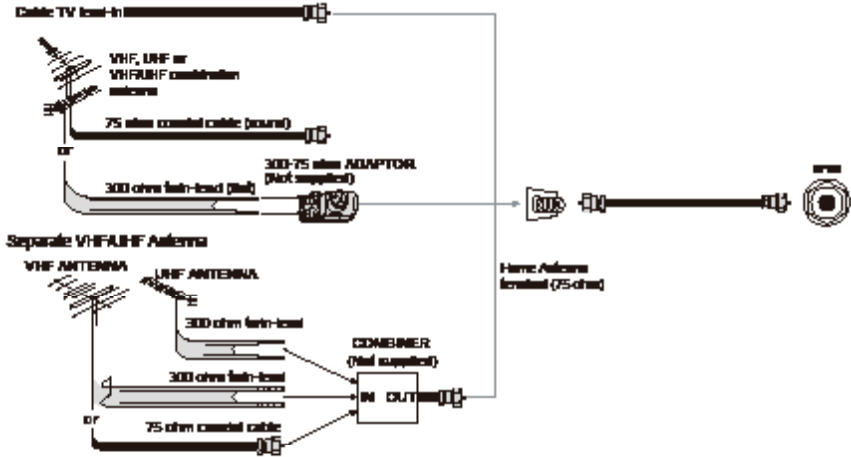

► **NOTE:**

The F-type connector should be finger-tightened only.

When connecting the RF cable to the LCD TV, do not tighten F-type connector with any tool. If tools are used, it may cause damage to the LCD TV (e.g. breaking of internal circuit).

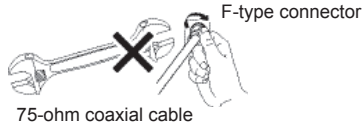

INSTALLATION

Cable TV (CTV/DTV) Connection

The unit has a TV tuner (75 ohm coaxial cable connector) located on the right I/O panel for easy cable hookup. When connecting the 75 ohm coaxial cable to the unit, screw the 75 ohm cable to the TV tuner.

Some cable TV companies offer premium pay channels. Since the signals of these channels are scrambled, a cable TV converter/descrambler is usually provided to the subscriber by the cable TV company. This converter/descrambler is necessary for normal viewing of the scrambled channels. (Set your TV to channel 3 or 4. Typically one of these channels is used. If a channel is unknown, consult your cable TV company.) For more specific instructions on installing cable TV, consult your cable TV company. One possible method of utilizing the converter/descrambler provided by your cable TV company is explained below.

A position on the RF switch (not supplied): You can view all unscrambled channels by using the TV's channel keys.

B position on the RF switch (not supplied): You can view the scrambled channels via the converter/descrambler by using the converter's channel keys.

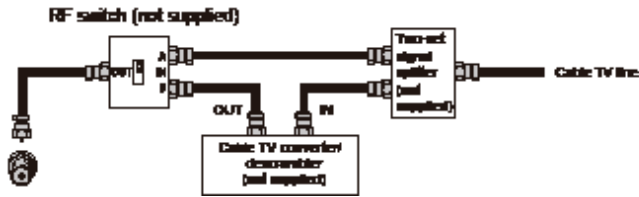

4. EXTERNAL DEVICE CONNECTIONS

You can enjoy picture and sound by connecting various audio-video devices to the terminals located on the left and right I/O panels of the LCD TV.

IMPORTANT:

Turn off the LCD TV first before connecting an external device to prevent any possible damage or physical injury.

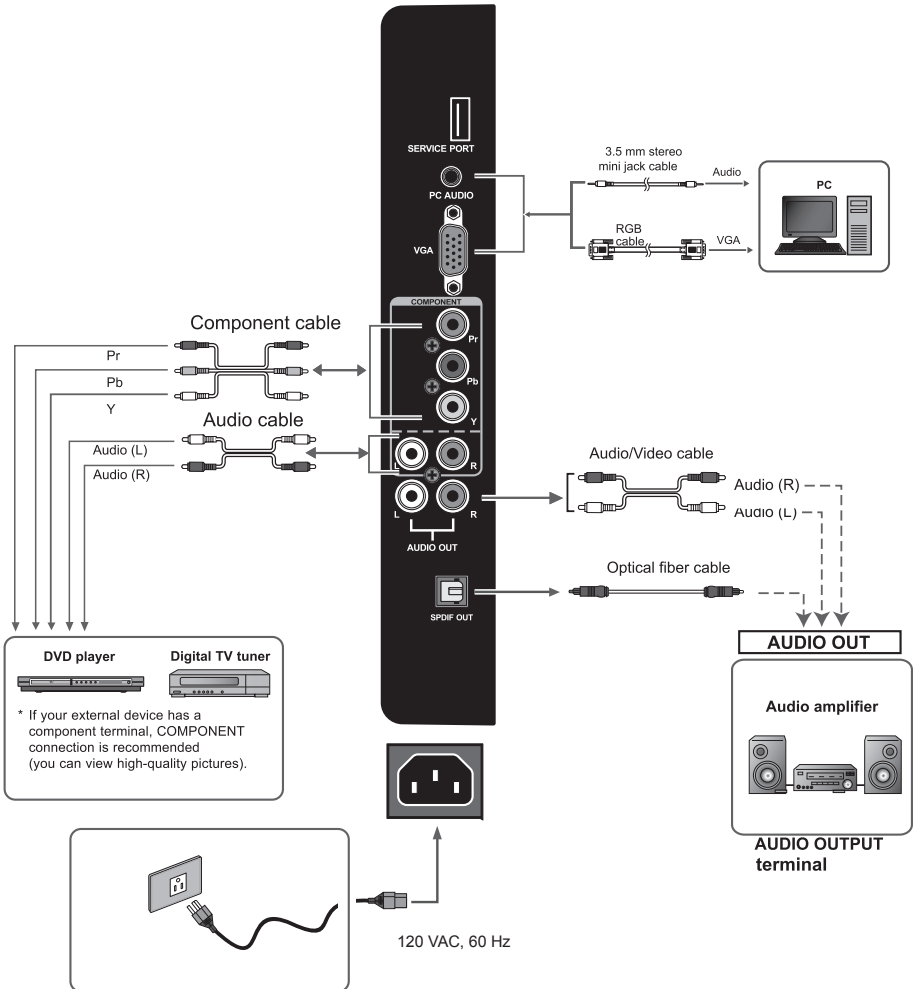

INSTALLATION

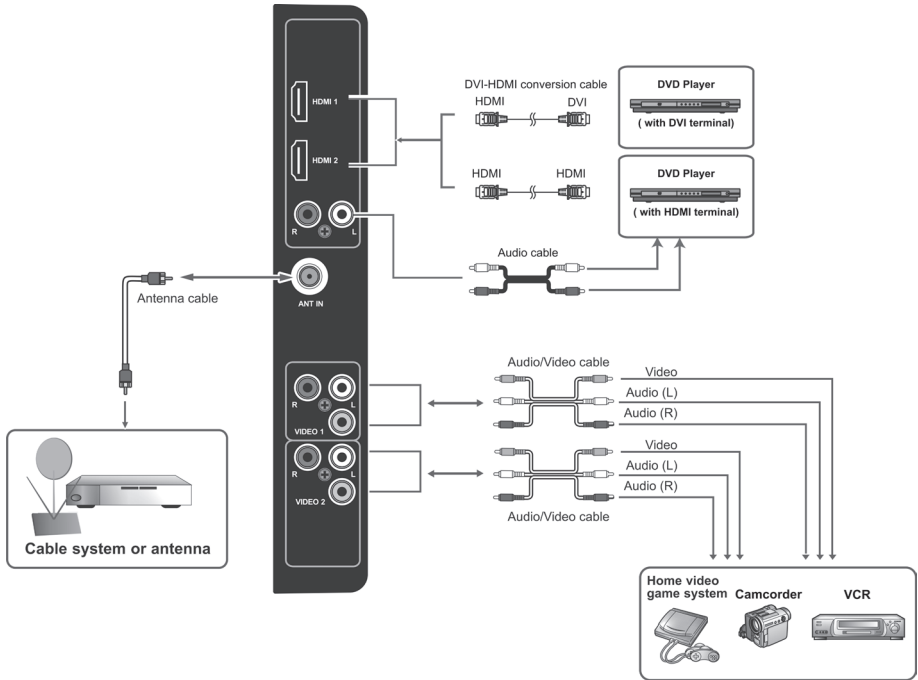

- For more information about external device connections, see the operation manual of the external device you wish to connect to the LCD TV.
- Make sure that the correct cables are connected to each terminal. Improper cable connections may cause damage to the LCD TV.
- TV cable input: You can use a commercially available audio/video cable.
- Component (YPbPr) input: Picture can be displayed only when a 480i, 480P, 720P or 1080i signal is received.
- HDMI input: Picture can be displayed only when a 640 x 480, 480P, 720P or 1080i signal is received. When you connect to the HDMI terminal with a DVI-HDMI conversion cable, there is a possibility that the picture may not display correctly.
- Audio output: You can output audio signals from the LCD TV set through the analog audio out and SPDIF terminals.
- This TV does not support DTS audio format. You may not hear proper audio output from the TV speakers if you choose a DTS audio format.

5. POWER CONNECTION



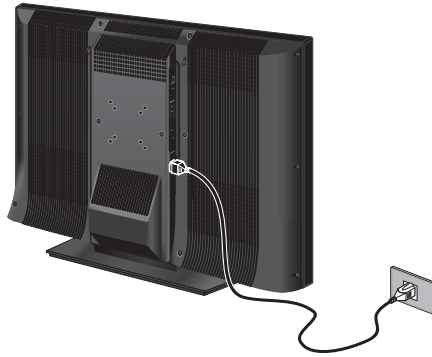

Connect the power cord to the LCD TV then to a proper AC outlet.

IMPORTANT:

The LCD TV works on a 120 VAC, 60 Hz power input voltage ONLY. Turn off all connected devices before plugging in the power cord.



6. INITIAL SETUP

Press  on the control panel or on the remote control to turn on the LCD TV. When you turn on the LCD TV for the first time, you will be prompted to perform a channel scan. Use the / keys to select a channel source and then press .

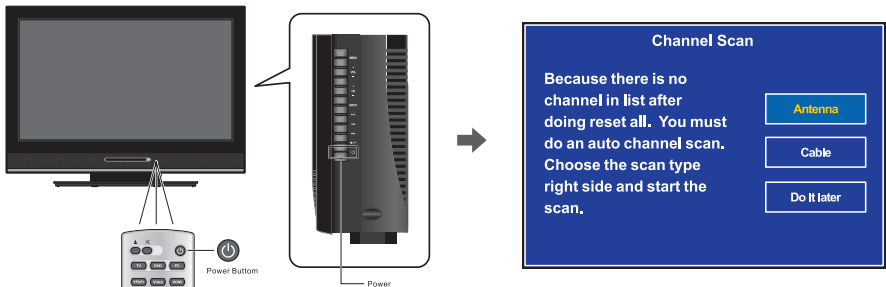

BASIC OPERATION

1. TURNING THE POWER ON AND OFF

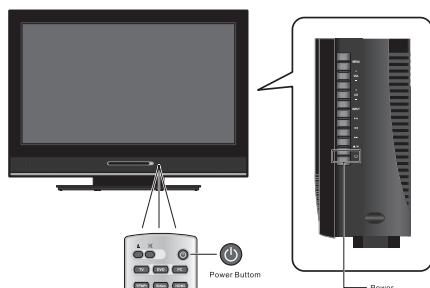

Indicator Status	Description
Power on	Blue light
Standby mode (DPMS on)	Amber light
Power off	No light

► **NOTE:**
The power indicator will illuminate from inside the disc slot. For more information on power mode configuration, go to page 43.

To turn on the power:

Press on the control panel or on the remote control. A blue light will illuminate from inside the disc slot.

To turn off the power:

Press on the control panel or on the remote control. The LCD TV shut down behavior will depend on the enabled Power Mode setting. Go to page 43 for related information.

► NOTES:

- If you are not going to use the TV for a long time, be sure to disconnect the power cord from the wall outlet and remove the batteries from the remote control.
- In standby mode, a small amount of electricity is still consumed even when the power is turned off, as indicated by an amber light illuminating from inside the disc slot

2. ADJUSTING THE VOLUME

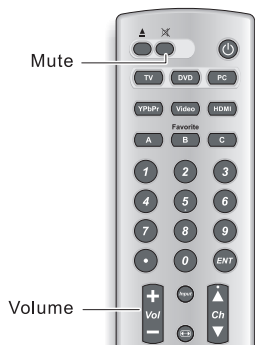

- Press **Vol+** to increase the volume. The bar indicator shifts right. Press **Vol-** to decrease the volume. The bar indicator shifts left.



- Press to turn off the sound. *Mute* appears on the volume bar. Press again to turn on the sound.



3. CHANGING CHANNELS

There are several ways to change channels. Unless otherwise indicated, the buttons referred to in the following instructions are located on the remote control.

Using the Ch ▲/▼ Buttons

To browse through the available channels, press **Ch▲** or **Ch▼** on the remote control or on the control panel.



Using the Channel Keys



To use the Channel Select function:

Key in the channel number using the 0 thru 9 buttons and then hold down the button for the last digit.

To select a standard channel:

Complete the following steps within 4 seconds. You can enter a single, double, or triple digit channel number (7, 12, 012, etc.).

- (1) Key in the channel number using the 0 thru 9 buttons.
- (2) Press **ENT**.

To select a digital channel:

Complete the following steps within 4 seconds.

- (1) Key in the main channel number using the 0 thru 9 buttons.
- (2) Press **●**.
- (3) Key in the sub-channel number using the 0 thru 9 buttons.
- (4) Press **ENT**.

Using the Favorite Keys



To select a favorite channel:

Press the Favorite button (**A**, **B**, or **C**) corresponding to the preferred favorite channel.

To save a channel as a favorite:

- (1) Display the channel you want to add as a favorite.
- (2) Press and hold the Favorite channel key you want to add the current channel to.
The *Channel Saved* message appears to confirm the new favorite channel item.



BASIC OPERATION

4. SELECTING THE INPUT SOURCE

There are two ways to select the video input source.

Using the Individual Input Keys



Press any of the following remote control keys to change the input source: **TV, DVD, PC, YPbPr, Video, or HDMI.**

Using the Input Key



- (1) Press **Input**.
- (2) Press **▲/▼** to select the preferred source.
- (3) Press **↔** to switch to the selected input source.

► NOTE:

If you enable the Autosource function, the TV will automatically detect and switch to a new input connection (e.g. The TV will automatically switch to PC mode when you connect to a computer.). Go to page 43 for instructions on how to enable this function.

5. ADJUSTING THE DISPLAY FORMAT

The input source can sometimes affect the way images are displayed on-screen. You can adjust the display format to view the image properly.



- (1) Press **↔**.
- (2) Press **▲/▼** to select the preferred display format. Options include:
 - Standard – Picture is displayed in its original size.
 - Fill – Picture is displayed to cover the entire screen.
 - Overscan – Picture is scaled down to fit the display area.
- (3) Press **↔** to apply the new display format.

1. SETUP MENU OPERATION

Use the setup menus to configure the various operational settings of the LCD TV.



To display the setup menu screen:

Press  on the remote control or **MENU** on the control panel.

To navigate through the setup menu screen:

Use the buttons on the remote control or on the control panel to navigate through the menu screens.



Action	Remote Control Key	Control Panel Button
Display or close the menu screen.		MENU
<ul style="list-style-type: none"> Select and display a primary menu. Adjust sub-menu options expressed in levels (e.g. brightness level, volume level). 	◀/▶ → Enter	CH + / - → INPUT
<ul style="list-style-type: none"> Select and display a sub-menu. Select a menu or a sub-menu option. 	▲/▼ → Enter	VOL + / - → INPUT
<ul style="list-style-type: none"> Return to the primary menu tab from a sub-menu screen. Return to the previous screen. 	◀ or 	CH + or INPUT
Apply the selected menu setting or cycle though available menu options.	Enter	INPUT

► NOTES:

- Available menu options depends on the current LCD TV settings.
- A selected menu, sub-menu, or menu option is displayed in yellow.
- The last viewed menu or sub-menu screen will be displayed the next time you press .

SETUP MENUS

2. MENU SETTING SCREENS

There are five primary LCD TV setup menus. For details on the options available for these menus, refer to the page numbers indicated below. In addition, there is one dedicated menu for DVD operation. Go to page 56 for more information on this menu.

Picture

	Page
Settings.....	26
View Mode.....	27
Presets.....	27
Advanced.....	28
Reset.....	29

Audio

	Page
Bass.....	30
Treble.....	30
Balance.....	30
Analog Audio.....	31
Digital Audio.....	31
SPDIF.....	32
Level Set.....	32
TV Speaker.....	33
Reset.....	33

Channels

	Page
Channels List.....	34
Antenna Scan.....	35
Cable Scan.....	35

Settings

	Page
Closed Captions.....	36
Sleep Timer.....	40
PC/VGA.....	40
Menu Language.....	41
Date & Time.....	41
Power Mode.....	43
Autosource.....	43
Custom Label.....	44
FW Version.....	44
Reset All.....	45

Locks

	Page
Rating Locks.....	46
Change PIN.....	51
DVD Locks.....	52
Reset Locks.....	52

► NOTES:

- The screenshots used in this manual are for explanation purposes only and may differ in appearance from those displayed on your LCD TV.
- Depending on the current LCD TV settings, for example the input source, it may not be possible to view or adjust some menu items.

A. PICTURE

Use the Picture sub-menus to configure the display quality.

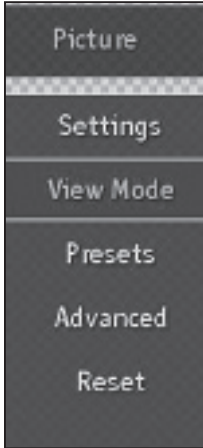

► **NOTE:**

The configuration settings for the Picture sub-menu will only be applied to the current input source.

A-1 Settings

Use the Settings sub-menu options to manually adjust the display quality. Use the ◀/▶ keys to adjust the option level.



- ➔ Adjust the luminance level.
- ➔ Adjust the brightness to darkness ratio.
- ➔ Adjust the balance of the red, green, and blue colors in the display.
- ➔ Adjust the color intensity.
- ➔ Adjust the sharpness or softness of the display.
- ➔ Adjust the brightness level of the screen backlight.

SETUP MENUS

English

A-2 View Mode

Use this sub-menu to select the display's aspect ratio. Use the ▲/▼ keys to select the preferred setting.

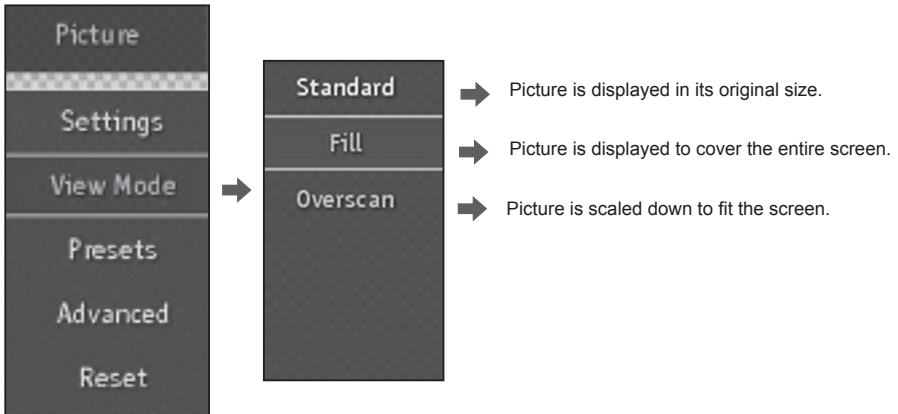

A-3 Presets

Use this sub-menu to select one of five preset view options optimized for different viewing conditions.

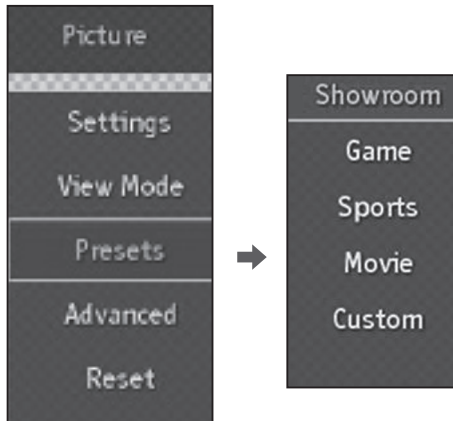



Preset Option	Description
Showroom	Increased color and sharpness for a vibrant picture display.
Game	Increased brightness and response time level for enjoying video games.
Sports	High contrast display for clear-cut images ideal for viewing sports events.
Movie	Images are displayed as accurately near to its original recording condition.
Custom	Allows the user to customize the display settings and select to which input source should the customize settings be applied.

A-4 Advanced

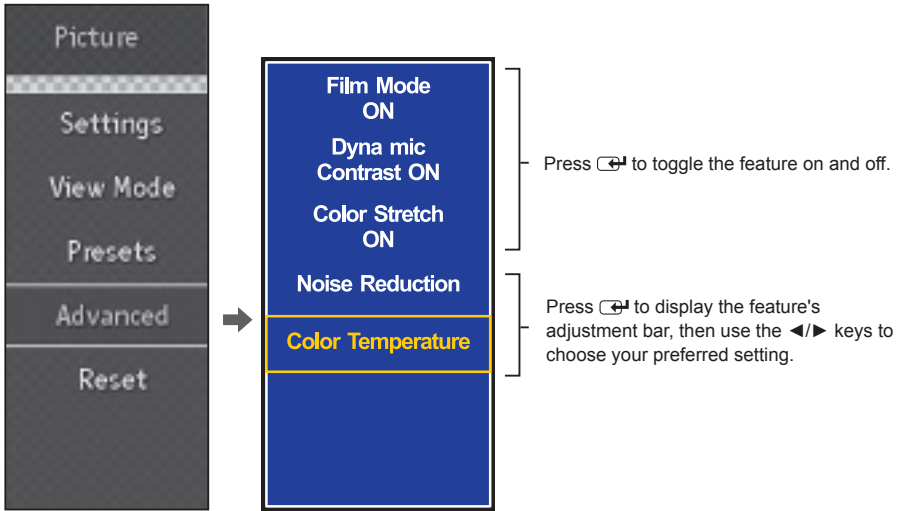
Select this sub-menu to adjust the picture quality in more detail.



Feature	Description
Film Mode	This feature improves the appearance of movies converted from film (originally encoded at 24 frames/second) to video, including DVD titles. When enabled picture is less jerky and has a cinematic picture quality.
Dynamic Contrast	This feature enables automatic contrast adjustment based on the picture brightness.
Color Stretch	This feature allows for a more vivid color display.
Noise Reduction	This feature improves picture quality from a weak broadcast signal. There are four available settings as indicated below: 
Color Temperature	Color temperature refers to the level of white balance in the display. There are four available settings:  <ul style="list-style-type: none"> • Warm - Pictures appear more reddish. • Neutral - Pictures appear more white. • Cool - Pictures appear with a bluish tint. • Custom - Select this option, and then press ON/OFF to manually adjust the RGB (red, green, blue) levels. Default levels are set at Neutral.

SETUP MENUS

A-5 Reset

Select **Yes** on this sub-menu to reset all Picture-related settings.

English

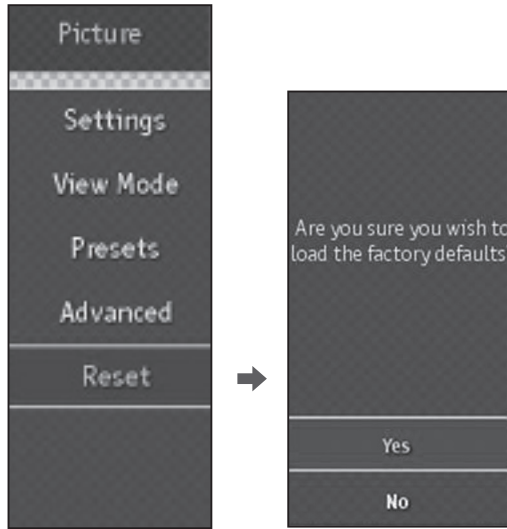

B. AUDIO

Use the Audio sub-menus to configure the audio quality. These settings apply to the LCD TV speakers, not to any connected audio device.



► **NOTE:**
The configuration settings for the Audio sub-menus will be applied to all input sources.

B-1 Bass / B-2 Treble / B-3 Balance

Use these sub-menus to adjust the sound pitch quality and the balance between the L/R speakers.



Press to display the option's adjustment bar, then use the keys to choose your preferred setting.

Audio Aspect	Description
Bass	Calibrate low-pitched sounds.
Treble	Calibrate high-pitched sounds.
Balance	Adjust the sound balance between the L/R speakers.

SETUP MENUS

B-4 Analog Audio

Use this sub-menu to select the preferred audio stream for viewing analog TV programs.

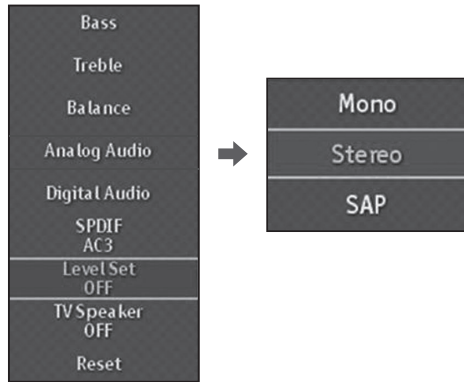

Signal	Description
Mono	Only one of the speaker channels is used to broadcast audio signals (single stream).
Stereo	Both speaker channels are used to broadcast audio signals (L/R streams).
SAP	SAP (Second Audio Program) enables audio signals to be broadcasted in a second language.

B-5 Digital Audio

Use this sub-menu to select the preferred language track for viewing digital TV programs. Available language options will depend on your digital TV provider.

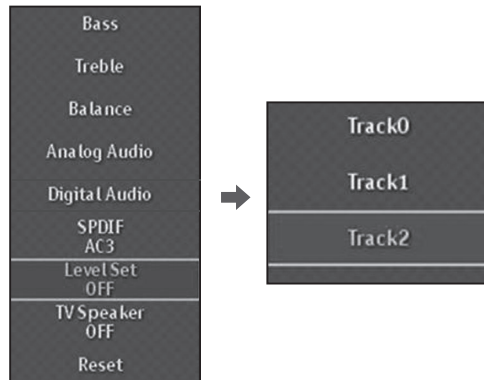

B-6 SPDIF

Use this sub-menu to select the preferred audio format for SPDIF audio signals.



▶ NOTE:
SPDIF is only available when watching DVDs or digital TV.

Press **↔** to cycle between options.

Option	Description
AC3	Surround audio format
PCM	Stereo audio format

B-7 Level Set

Use this sub-menu to select the target inputs to apply the audio settings to.



Press **↔** to cycle between options.

Option	Description
OFF	Audio settings will be retained for all input sources, as well as for both analog and digital TV channels.
ON	Audio settings will be only applied to the input source/ TV signal currently being watched.

SETUP MENUS

English

B-8 TV Speaker

Use this sub-menu to toggle the LCD TV speakers on and off. Press **↔** to cycle between options.



B-9 Reset

Select **Yes** on this sub-menu to reset all Audio-related settings.

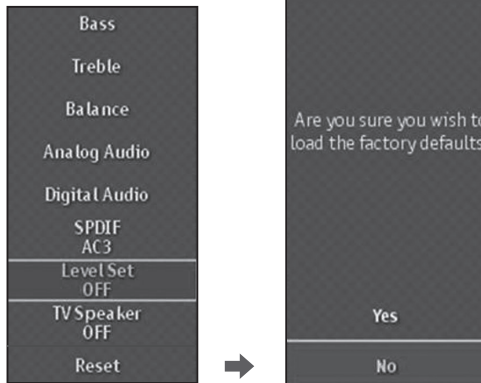

C. CHANNELS

Use the Channel sub-menus to view the channel list and to scan for available TV channels in your area.

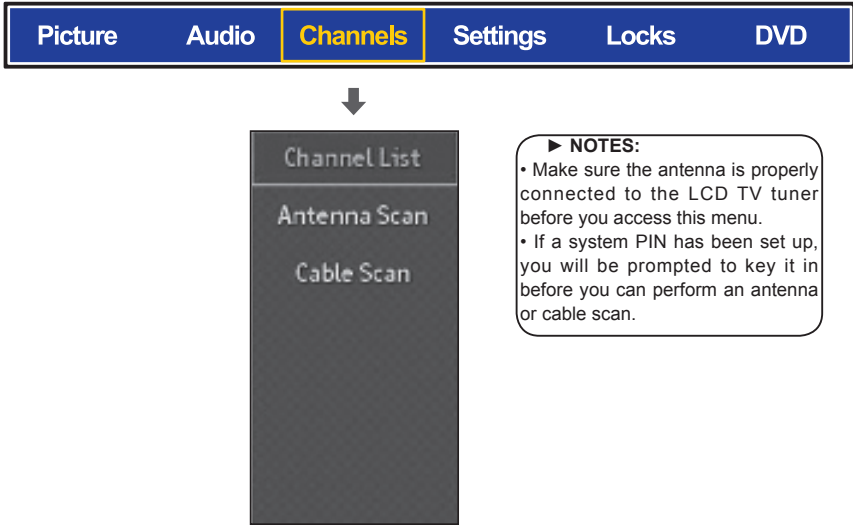

C-1 Channel List

Use this sub-menu to view the list of all available TV channels saved in the unit's memory.

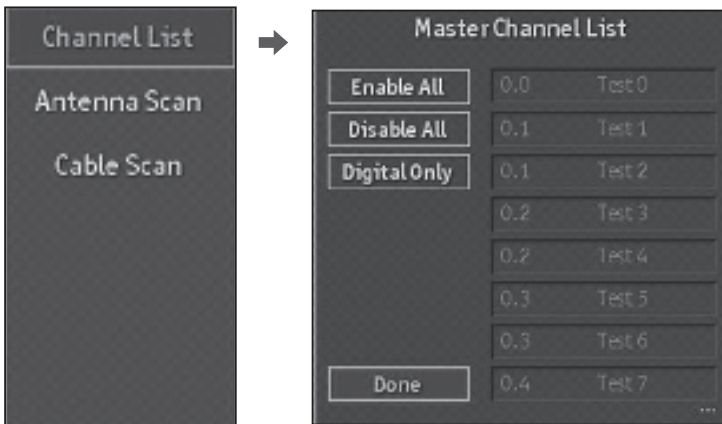

You can choose to enable/disable all available channels or to enable the digital ones only. Use the ◀/▶ keys to select one of the options, select **Done**, and then press .

SETUP MENUS

English

C-2 Antenna Scan

Select **Yes** on this sub-menu to scan for available over-the-air and digital channels in your area.

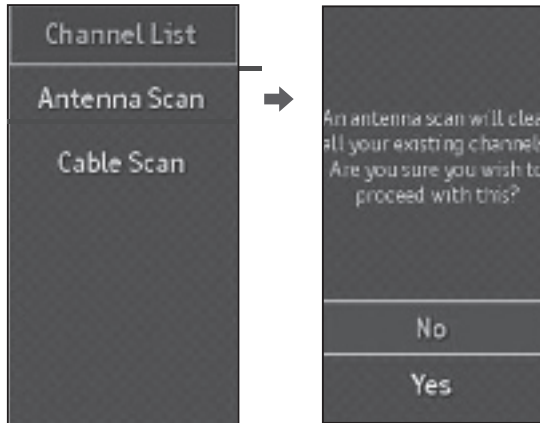

C-3 Cable Scan

Select **Yes** on this sub-menu to scan for available cable and digital channels in your area.

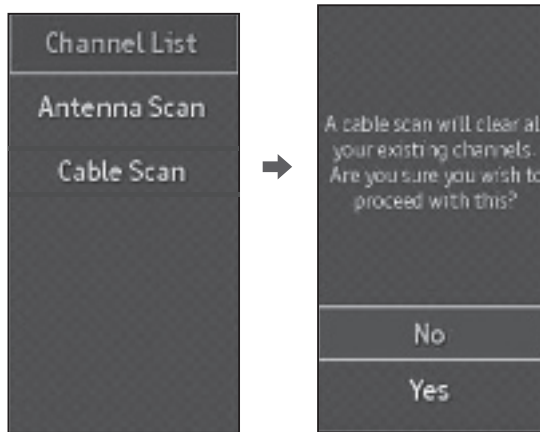

D. SETTINGS

Use the Settings sub-menus to configure the LCD TV operational setup and view the current firmware version.

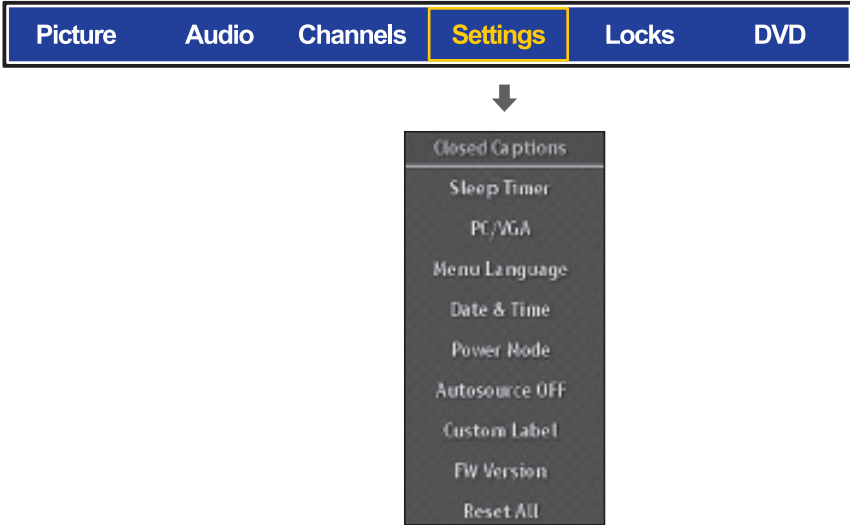

D-1 Closed Captions

Use the Closed Captions sub-menus to configure the settings for closed captioning (CC, also known as subtitles) in TV programs. CC are primarily intended to allow people who are deaf or hard of hearing to access TV programs. However, this feature is also useful for viewers who are learning a new language, beginning to read, or in a noisy environment. As the video plays, text captions are displayed that transcribe speech and often other relevant sounds.

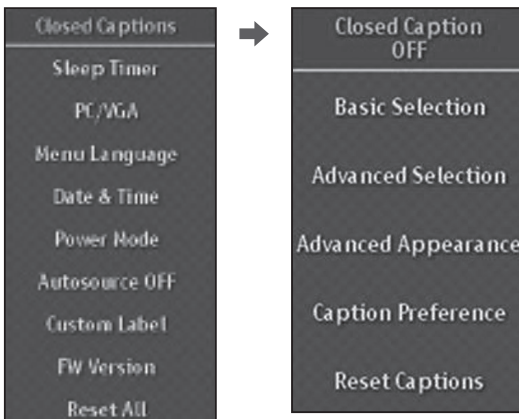

- **NOTES:**
- This menu only applies to the CC feature of TV programs. Access the *DVD | Subtitle* sub-menu to configure the CC settings for viewing DVD titles.
 - CC availability and content is dependent on your TV provider and may vary across channels and TV programs.

SETUP MENUS

D-1-1 Closed Caption

Use this sub-menu to enable or disable closed captioning in TV programs.



➔ Press  to cycle between the OFF and ON settings.

D-1-2 Basic Selection

Use this sub-menu to select the preferred closed captioning content. Most closed caption content can be found within the CC1 setting.

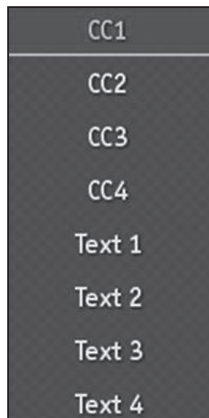
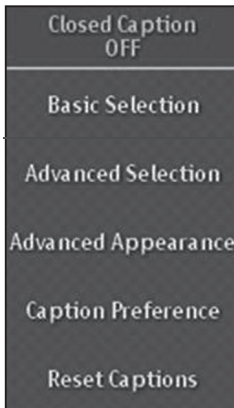

D-1-3 Advanced Selection

Use this sub-menu to select enhanced closed captioning content.



► **NOTE:**
This sub-menu is only available for digital TV programming. The availability is dependent on your digital TV provider and may vary across channels and TV programs.

D-1-4 Advanced Appearance

Use this sub-menu to customized the way closed captions are displayed.

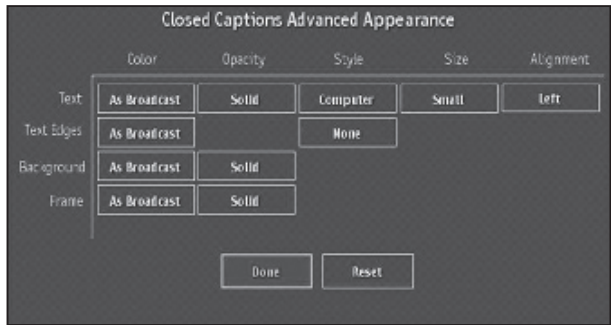
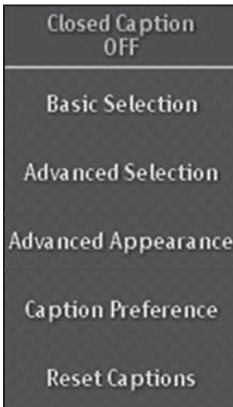

- (1) Use the ◀/▶/▲/▼ keys to select a CC aspect.
- (2) Press **CH** to cycle between the options available for the selected aspect.
- (3) Select **Done**, and then press **CH**.

SETUP MENUS

English

D-1-5 Caption Preference

Use this sub-menu to select which CC mode to implement for TV programs providing CC content.

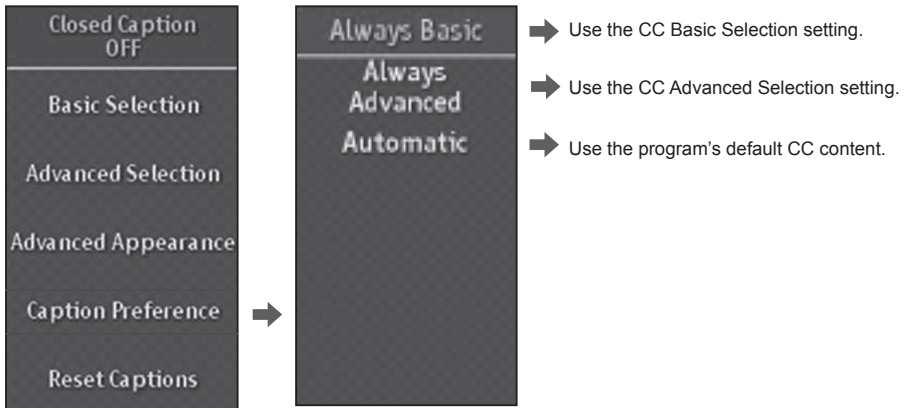

D-1-6 Reset Captions

Select **Yes** on this sub-menu to reset all CC-related settings.

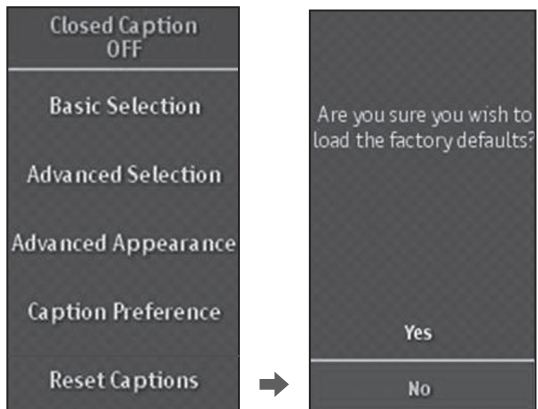

D-2 Sleep Timer

Use this sub-menu to select the duration after which the TV will automatically turn off.

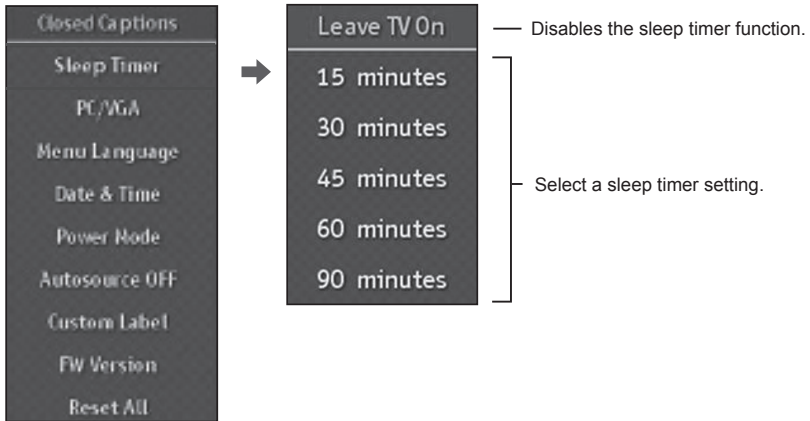

D-3 PC/VGA

Use this sub-menu to configure VGA-related settings applicable when you connect the TV to a computer.

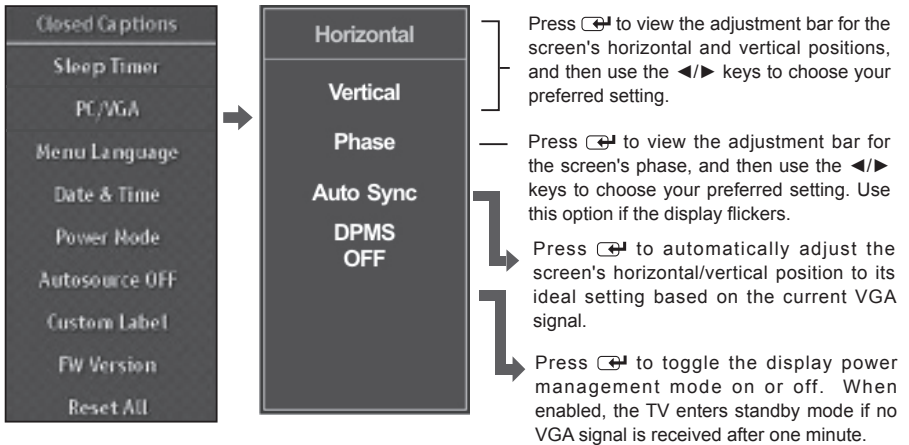

SETUP MENUS

D-4 Menu Language

Use this sub-menu to select which language to use for on-screen menus.

English

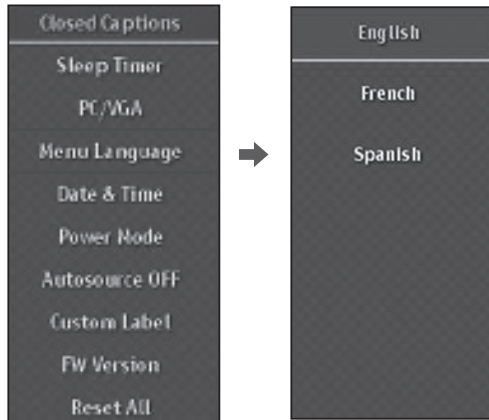

D-5 Date & Time

Use this sub-menu to configure the system clock and time zone settings. You can also choose to enable the Daylight Saving Time (DST) and Auto Update functions.

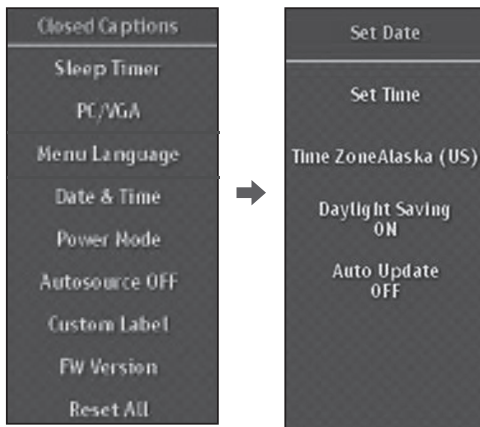

D-5-1 Set Date / D-5-2 Set Time / D-5-3 Time Zone

Use these sub-menus to configure the system clock and time zone settings.

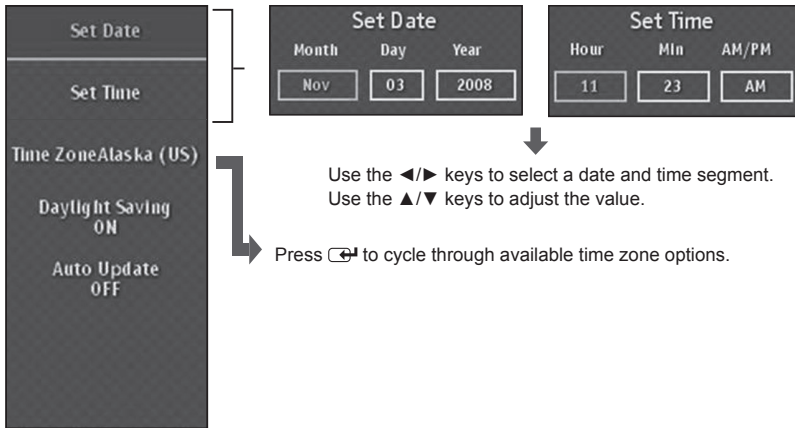

► NOTE:

The system date and time settings are not configurable if the Auto Update function is enabled. Clock settings will depend on the TV broadcast stream.

D-5-4 Daylight Saving / D-5-5 Auto Update

Use these sub-menus to toggle the DST and Auto Update functions on or off.

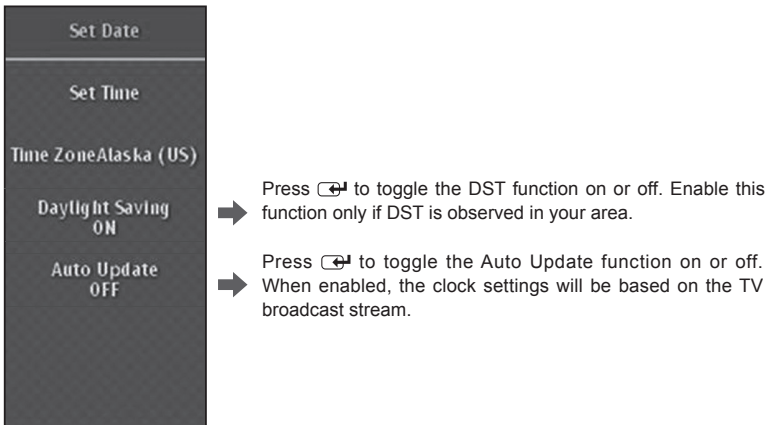

SETUP MENUS

D-6 Power Mode

Use this sub-menu to select the LCD TV behavior when it is turned off.

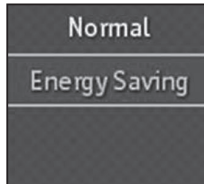

Press to cycle between options.

Mode	Description
Normal	The TV enters a low-power standby state (backlight is turned off). The TV can be quickly turned on next time.
Energy Saving	All system power is turned off. The TV must be fully booted each time you turn it on.

D-6 Autosource

Use this sub-menu to toggle the Autosource function on or off.



Press to cycle between options.

Option	Description
ON	The TV will automatically detect and switch to a new input connection (e.g. The TV will automatically switch to PC mode when you connect to your computer.).
OFF	User will need to manually switch to the new input using the Input key or the individual input source keys on the remote control.

D-8 Custom Label

Use this sub-menu to assign a device label for each of the input terminals. These labels will be displayed when you press any of the individual input source keys.

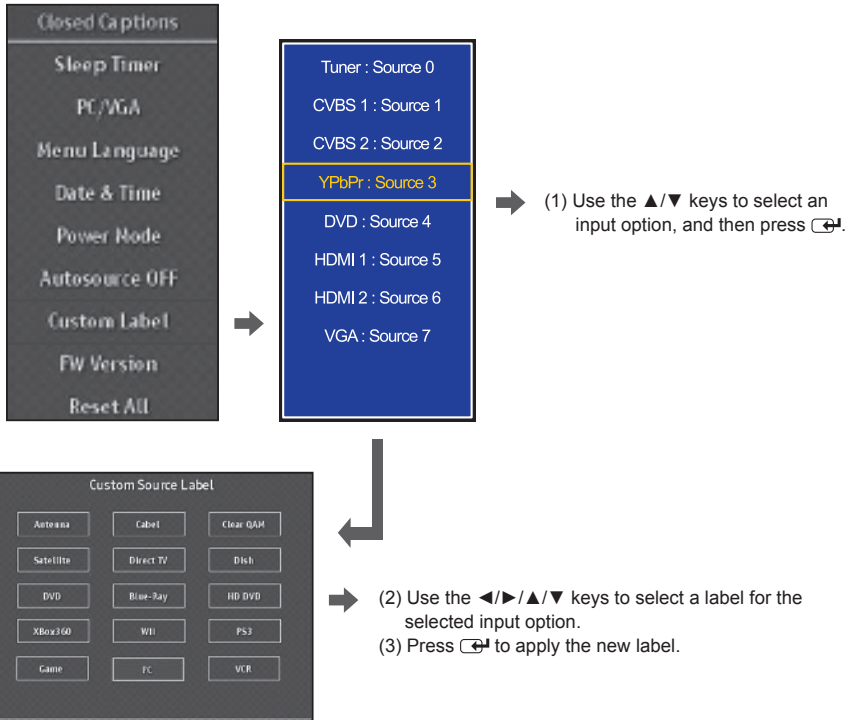

D-9 FW Version

Use this sub-menu to view the firmware version and the current input source.

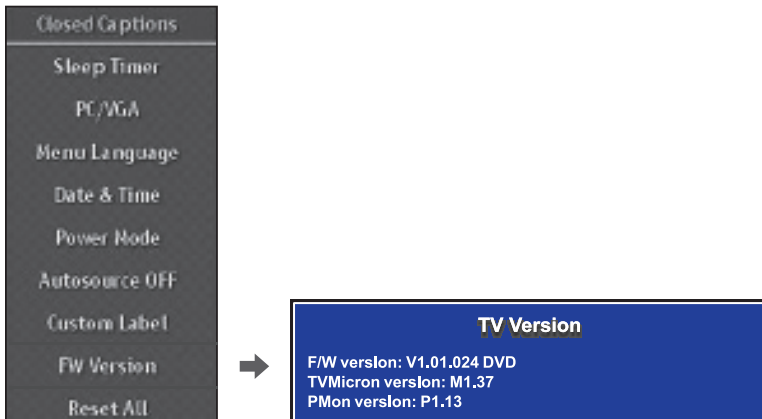

SETUP MENUS

D-10 Reset All

Select **Yes** on this sub-menu to reset all LCD TV operational settings. Do this only if any of the following conditions occurs:

- The system fails to respond to the remote control (make sure the remote control batteries are still working and that you are within the transmission range).
- The new configuration settings caused unexpected results.
- You forget the system PIN.

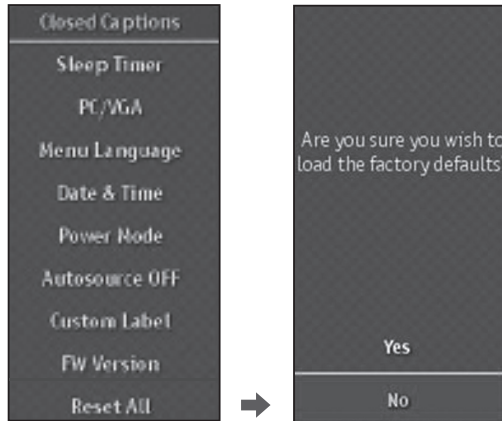

► **NOTES:**

- If a system PIN was set up earlier, you will be prompted to enter it to access this sub-menu. If you have forgotten your PIN, key in **0000**. This is the default PIN.
- After the system reset, the screen will automatically display the Channel List menu. Perform a channel scan to reload the channels to your LCD TV.

E. LOCKS

Use the Locks sub-menus to change the system PIN and set allowable video content for TV programs and DVD titles based on their rating levels.



The first time you access the Locks menu, you will be prompted to set a system PIN. Key in your 4-digit PIN.

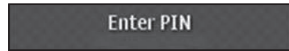

You will be prompted to key in this PIN everytime you try to access the Locks menu and the Settings | Reset All sub-menu.

E-1 Ratings Locks

Use this sub-menu to set allowable video content for TV programs (using the TV tuner) based on their rating levels. This will allow users parental control on the kind of TV programs their kids can access.

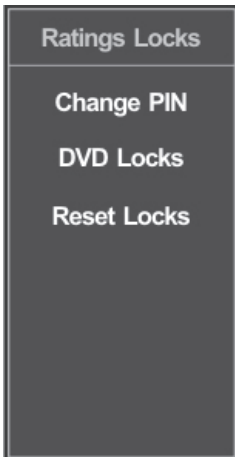

► **NOTE:**
This sub-menu is only valid for the North American market.

SETUP MENUS

English

E-1-1 Block Unrated Shows

Use this sub-menu to block viewing of all unrated TV programs.

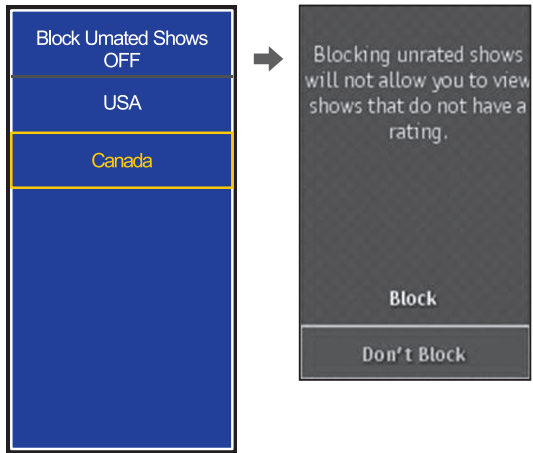

E-1-2 USA

Use this sub-menu to select the rating levels (based on US ratings) of allowable TV programs and movies.

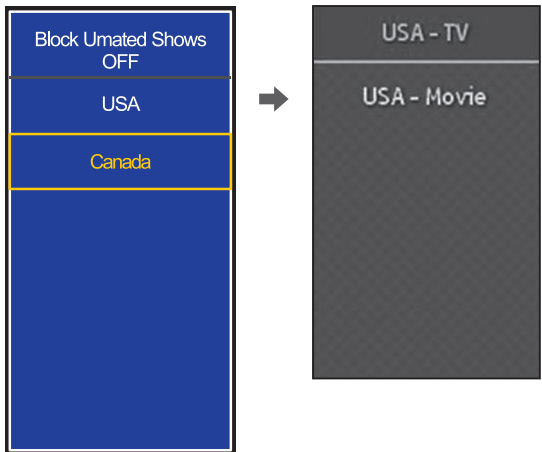

SETUP MENUS

E-1-2-1 USA - TV

Use this sub-menu to select the ratings of allowable TV programs. These ratings are determined by the Federal Communications Commission (FCC).

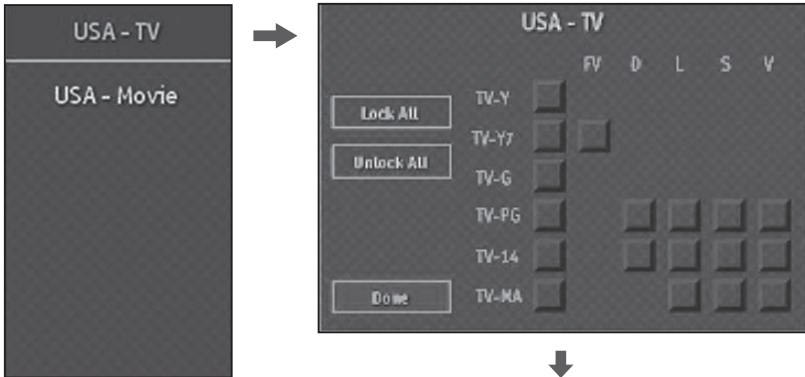

- (1) Use the ◀/▶/▲/▼ keys to select a rating box.
- (2) Press **OK** to block TV programs rated as such.
- (3) Select **Done**, and then press **OK**.

Age-based Rating	Content Designation	Description
TV-Y		Suitable for young children
TV-Y7		May not be suitable for children under 7
TV-G		Suitable for all audiences
TV-PG		Parental guidance suggested
TV-14		Parental guidance suggested for children under 14
TV-MA		Suitable for mature audiences only; may be unsuitable for children under 17
	FV	Fantasy violence, combative situations
	D	Suggestive dialogue
	L	Coarse language
	S	Sexual situations
	V	Violence

► **NOTE:**

Selecting a lower age-based rating block takes precedence over content-rating designation.

SETUP MENUS

E-1-2-2 USA - Movie

Use this sub-menu to select the ratings of allowable movies. These ratings are determined by the Motion Picture Association of America (MPAA).

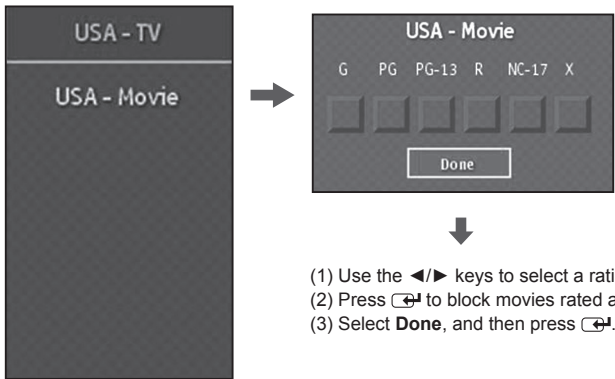

Rating	Definition	Content Description
G	General Audience Admitted	Contains nothing most parents will consider offensive for even their youngest children to see or hear; suitable for young children.
PG	Parental Guidance Suggested	May contain some material parents might not like to expose to their young children—material that will clearly need to be examined or inquired about before children are allowed to view the film.
PG-13	Parents Strongly Cautioned	May contain some scenes of drug use; use of one of the harsher sexually-derived words may be heard. May be inappropriate for pre-teens.
R	Restricted	May contain some adult material. Parents are urged to learn more about the film before letting their children view it.
NC-17	No One 17 and Under Admitted	May contain explicit sex scenes, an accumulation of sexually-oriented language, and/or scenes of excessive violence. Suitable for adult audiences only. Rating does not signify that the film is obscene or pornographic.
X	X Rated	Contains extreme violence or explicit sex; suitable for adults audiences only.

E-1-3 Canada

Use this sub-menu to select the classification categories (based on Canadian ratings) of allowable TV programs and movies.

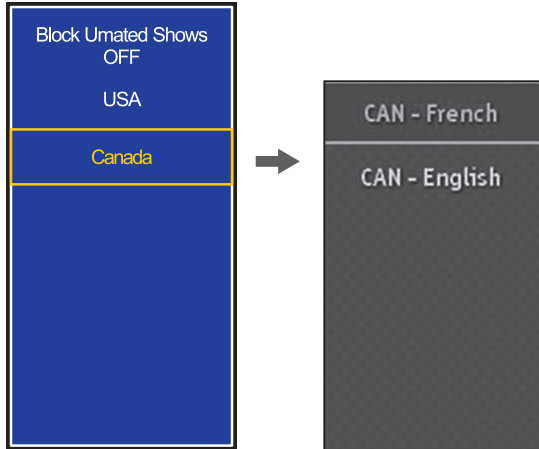

E-1-3-1 CAN - French

Use this sub-menu to select the ratings of allowable TV programs and movies. These ratings are based on the classification categories determined by La Régie du cinéma du Québec.

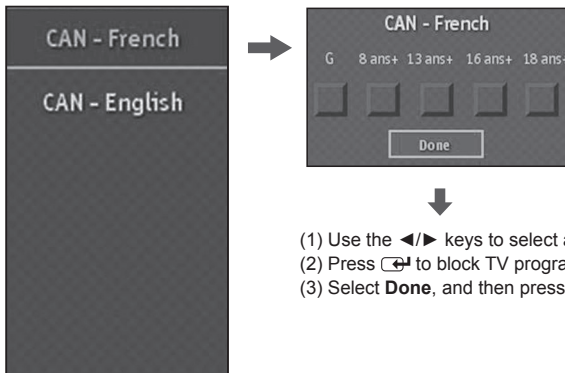

Classification	Audience Restriction
G	For general audiences
8 ans+	Not suitable for children under 8 years of age
13 ans+	Not suitable for persons under 13 years of age
16 ans+	Not suitable for persons under 16 years of age
18 ans+	Not suitable for persons under 18 years of age

SETUP MENUS

E-1-3-2 CAN - English

Use this sub-menu to select the ratings of allowable TV programs and movies based on the Canadian Home Video Rating System determined by the Canadian Motion Picture Distributors Association (CMPDA).

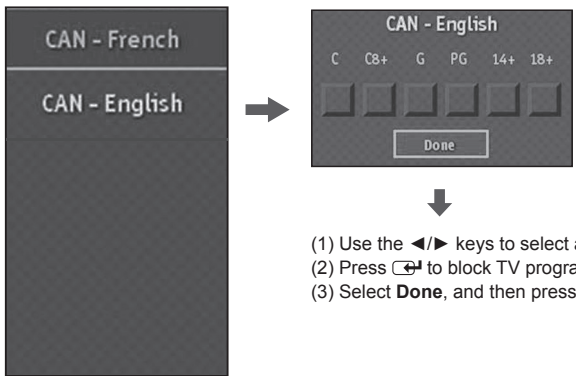

- (1) Use the ◀/▶ keys to select a rating box.
- (2) Press **OK** to block TV programs and movies rated as such.
- (3) Select **Done**, and then press **EXIT**.

Classification	Description
C	Suitable for viewing by children of all ages
C8+	Not suitable for children under 8 years of age
G	Suitable for general audiences
PG	Parental guidance advised
14+	Suitable for people 14 years of age or older
18+	Suitable for people 18 years of age or older

E-2 Change PIN

Use this sub-menu to change the system PIN in case the original one has been compromised. You will need to key in the original PIN. If you forget the original PIN, you need to perform the *Reset All* option under the *Settings* sub-menu.

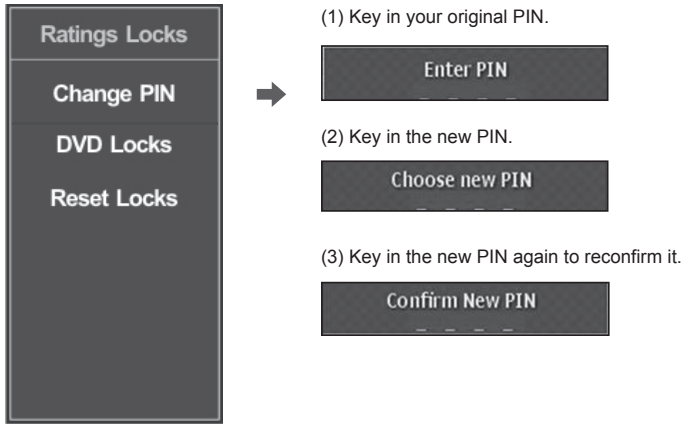

(1) Key in your original PIN.

(2) Key in the new PIN.

(3) Key in the new PIN again to reconfirm it.

E-3 DVD Locks

Use this sub-menu to control the DVD content that can be played on the LCD TV.

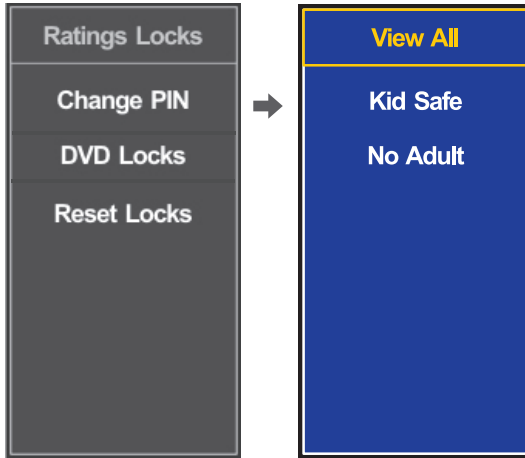

Use the ▲/▼ keys to select a DVD lock option.

Option	Description
View All	DVD titles can be viewed in its entirety.
Kid Safe	DVD content appropriate for children age 12 and under can be viewed.
No Adult	DVD content appropriate only for adults can not be viewed.

E-4 Reset Locks

Select **Yes** on this sub-menu to reset the system PIN and all parental lock settings to their default unlock status.

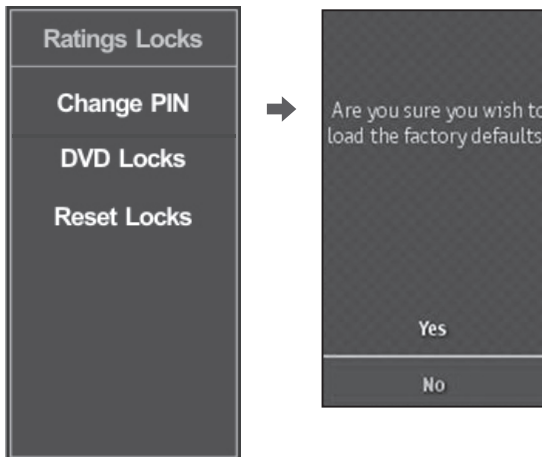

DVD PLAYER

1. PLAYING MULTIMEDIA FILES

Use the DVD drive in this unit to play your favorite multimedia files. In addition to DVD playback, the unit also support playback for the following file formats: MP3, WMA, and JPEG.

- (1) Press **⏻** on the control panel or on the remote control to turn on the LCD TV.
- (2) Press **DVD** on the remote control to switch to DVD mode. The DVD mode prompt will be displayed.



- (3) Press **▲** to engage the disc slot. The *Open* icon appears on-screen.

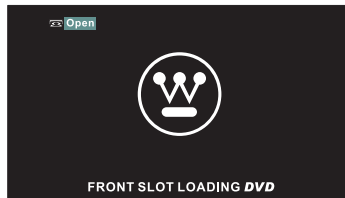

- (4) Hold the disc by its edges and with the label side facing upward, then align it against the disc slot. The disc will be automatically loaded into the drive. **DO NOT FORCE** the disc inside. The *Loading* message appears on the upper-left corner of the screen. File playback will automatically start.

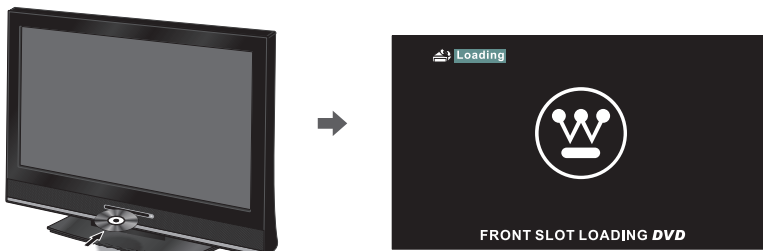

► NOTES:

- When there is a disc in the slot, playback will automatically start when the DVD button is pressed.
- You can enable the Autosource function to automatically switch to DVD mode everytime a disc is loaded. Go to page 43 for details.
- If you load a disc with the label side facing downward, the *NO DISC* message appears. Press **▲** and load the disc properly.

2. MULTIMEDIA MODES

The playback screen varies according to the media type—video (DVD), audio (MP3 or WMA), or picture (JPEG).

- **For DVD playback**, the first chapter or title will be played unless the DVD has its own menu, then it would appear first. Use the ◀/▶/▲/▼ keys to select a title, and then press ▶|| to start playback.
- **For audio playback**, the first track will be played. The track number and the lapsed playback time will be displayed. If the Repeat function is enabled, the Repeat mode icon will also be displayed (Track or ALL).

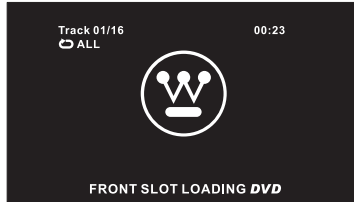

- **For JPEG playback**, the screen will display the disc's root directory. Files and folders will be listed on the left window panel, while the right side panel will show a preview of the selected JPEG file. Use the ◀/▶/▲/▼ keys to move around the screen.



To view a picture:

- (1) Select the image filename from its folder window.
- (2) Press ◀.

If there are multiple pictures in the selected folder, pictures will be presented in a slideshow. Each picture will be displayed for about five seconds before automatically going to the next picture. You can still use the ◀◀ and ▶▶ keys to view the previous and next pictures in the current folder.



DVD PLAYER

3. FILE PLAYBACK CONTROLS

The remote control has eight dedicated keys for controlling file playback, as well as for accessing the DVD setup menu. Use these keys to control playback for all multimedia file formats supported by this unit.

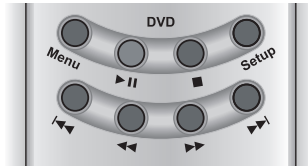

Name	Icon	Usage
Menu	—	If the DVD has its own menu screen, press this key to display it.
Play/Pause	▶	During pause: Press to resume playback. During playback: Press to temporarily stop playback.
Stop	■	Press to stop file playback.
Setup	—	Press to display the dedicated DVD setup menu. Go to the next page for more information.
Fast reverse	◀◀	Press to scan the audio/video file backward.
Skip reverse	◀◀	Press to go to the previous chapter, track, or picture in the current disc/folder. Each time you press this key, a chapter, track, or picture is skipped.
Fast forward	▶▶	Press to scan the audio/video file forward.
Skip forward	▶▶	Press to go to the next chapter, track, or picture in the current disc/folder. Each time you press this key, a chapter, track, or picture is skipped.
NOTE: Each press of the ◀◀ and ▶▶ keys increases the scan speed (x 2, x 4, x 8, and x 20). To resume normal playback, press ▶ .		

4. DVD SETUP MENUS

Use the DVD setup sub-menus to configure the way multimedia files are played in your LCD TV. To access the related setup screen, press **Setup** on the remote control.

► **NOTE:**

Some DVDs have producer-specific DVD operational encodings. This will take precedence over the DVD playback settings of your LCD TV.

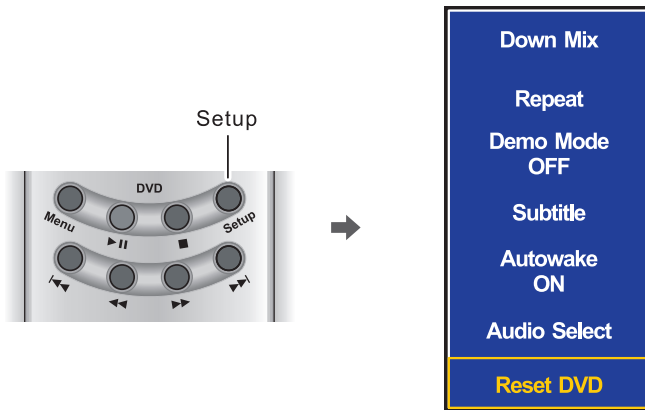

Sub-menu	Function
Down Mix	Select which channel to use for audio/video playback. Use the ▲/▼ keys to select an option: Stereo or LT/RT.
Repeat	Select a Repeat mode to apply when playing audio/video files. During file playback, press Setup and then select Repeat . Press ↺ repeatedly to cycle through the available options. <ul style="list-style-type: none"> • DVD: Chapter, Title, or All • Audio: Track or All
Demo Mode	Select to toggle the Demo Mode function on or off. When enabled, the DVD menu (if available) will be skipped.
Subtitle	Select a subtitle language for DVD playback. This option will depend on the available subtitle options encoded in the DVD. During playback, press Setup and then select Subtitle . Press ↺ repeatedly to cycle through the available options.
Autowake	Select to toggle the Autowake function on or off. When enabled, loading a disc when the LCD TV is turned off will allow the unit to automatically turn on and start playback.
Audio Select	Select the audio language for DVD playback. This option will depend on the available language tracks encoded in the DVD. During playback, press Setup and then select Audio Select . Press ↺ repeatedly to cycle through the available options.
Reset DVD	Select Yes on this sub-menu to reset all DVD setup settings.

DVD PLAYER

5. MP3/WMA/JPEG CD INFORMATION

This LCD TV/DVD unit requires discs/recordings to meet certain technical standards in order to achieve optimum playback quality. Pre-recorded DVDs are automatically set to these standards. Given the fact that technology in the optical disc market is still maturing, there are many different types of recordable disc formats that you can use to burn multimedia files into (e.g. CD-R disc containing MP3/WMA files). This unit cannot guarantee that all types of recordable discs will produce optimum playback quality. The technical criteria set out in this manual are meant as a guide only.

IMPORTANT:

Please be advised that you must obtain permission from the applicable copyright owners to download copyrighted content, including music files, in any format, including the MP3 and WMA formats, prior to their downloading.

MP3/WMA/JPEG CD Playback Information

The LCD TV can play back MP3/WMA/JPEG files that have been recorded on a CD-R, CD-RW, DVD-R, or DVD-RW disc. To produce the MP3/WMA/JPEG disc, burn the files in a compatible disc using a Windows PC with a CD-RW or DVD-RW drive and an appropriate encoding software.

► NOTE:

You must use a Windows PC to burn the MP3/WMA/JPEG disc. This unit does not support data disc burned using the Apple Mac OS (Hierarchical File System, HFS format).

- Make sure the filename of the MP3/WMA/JPEG files in the burned disc includes the 3-character file extension ("mp3", "wma", or "jpg").
- MP3/WMA/JPEG CD must meet the ISO file standard.
- This LCD TV can only read 600 files per disc. If a directory has more than 600 files, the remaining files will be omitted during playback.
- This LCD TV can recognize a maximum of 50 directories per disc. If a disc has more than 50 directories, the last-listed directories will not be displayed.
- If the disc contains both audio (MP3 or WMA) and image (JPEG) files, only audio files can be played.
- It may take more than one minute for this unit to read a MP3/WMA/JPEG disc depending on its structure.
- Audio tracks recorded using the Joliet Recording Specification can be played back. The LCD TV can display up to 16-character filenames. Longer file names will be condensed. Only the following characters in a filename will be displayed: small or capital A-Z letters, numbers of 0 through 9, and the underscore symbol (_).
- To enable sequential file playback, use an encoding software that allows for playlist creation. In the playlist, make sure the files are alphabetically or numerically arranged. You can use numerical prefixes to arrange the files (i.e., "01-party pic" or "002-con call track").

MP3/WMA Encoding Information

Observe the following standard, sample rate, and bit rate specifications when creating an MP3 or WMA CD.

- **MP3 CD**

MPEG-1 Audio

32kHz, 44.1kHz, 48kHz

32 to 320 kbps (constant bit rate or variable bit rate)

The recommended recording conditions for optimum sound quality is is 44.1 kHz sample rate and 128 kbps constant bit rate.

- **WMA CD**

Up to 4 kbps (bit rate)

48k Hz, mono channel (48 kpbs is not supported)

SPECIFICATIONS

Item	Specification	
Model Name	SK-26H570D	
Panel	Type	26-inch Active Matrix WXGA TFT LCD
	Viewing angle	160° horizontal; 150° vertical
	Resolution	1366 x 768 (RGB vertical stripe)
	Color	16.2 million
Audio/Video Input Terminals	<ul style="list-style-type: none"> • VGA (75 ohms, 0.7 Vp-p) + PC audio-in (mini-stereo) H/V separated (TTL) for PC; fh: 30-63 kHz, fv: 50-75 Hz • HDMI 1 and HDMI 2 + RCA (L/R) stereo • TV tuner • YPbPr 1 + RCA (L/R) stereo • Composite 1 and Composite 2 + two RCA (L/R) stereos 	
Audio/Video Output Terminals	<ul style="list-style-type: none"> • RCA (L/R) stereo • SPDIF (optical) 	
Speaker Output	9W (2 channels)	
Image Processor	ATI Xilleon™ 241	
TV System Support	NTSC and ATSC	
TV Compatibility	480i, 480P, 720P, 1080i	
PC Compatibility	Recommended (reduced blanking)	1360 x 768 @ 60 Hz 1366 x 768 @ 60 Hz
	Supported	1280 x 720 @ 60 Hz 1024 x 768 @ 60 Hz 720 x 400 @ 70 Hz 640 x 480 @ 60, 75 Hz
	H = 30-63 KHz	
	V = 50-75 Hz	
DVD Player	Height	40.6 mm
	Loading mechanism	Slot loading
	Disc diameter	8 or 12 cm
	Video formats	ISO/IEC 11172 MPEG-1, 13818 MPEG-2 and 14496-2 MPEG-4
	Audio formats	Dolby Digital, MPEG-I/II Layer 1/2, PCM, LPCM, WMA and MP3
	Picture format	JPEG
	Disc formats	DVD-Video, DVD-Audio, DVD+RW, DVD+R, DVD-R, DVD-RW, CD-DA, VCD, SVCD, CD-R and CD-RW
Power Voltage	120 VAC, 60 Hz, 2.5A	
Power Consumption (DC)	On	<150W (blue illumination)
	Off in normal mode	Autowake is enabled: < 23W
	Off in energy saving mode	Autowake is disabled: < 2W
	Power saving mode	Autowake is on: < 6w (amber illumination)
Preset Timing Mode	Pre-adjusted to reduce blanking: 1366 x 768 @ 60 Hz	
Operating Conditions	Temperature	15 to +35°C (humidity < 75%)
	Relative humidity	20 to 90% non-condensing (Ta < 35%)
	Altitude	0 to 2,000 m
Storage Conditions	Temperature	-20 to +60°C (humidity < 35%)
	Relative humidity	10 to 90% non-condensing
	Altitude	0 to 12,000 m
Physical Specifications	Dimensions (W x D x H)	With base: 658 x 224 x 507 mm Without base: 658 x 175 x 465 mm
	Weight (net)	With base: 13.2 kg Without base: 12.1 kg
Regulations	UL/C-UL and FCC-B	
▶ NOTES: <ul style="list-style-type: none"> • These product specifications are subject to change without user notification. • Do not set your computer graphics card to exceed the unit's refresh rates; doing so may cause damage to the HDTV. 		

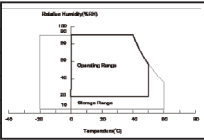

SPECIFICATIONS

Item	Specification	
Model Name	SK-32H570D	
Panel	Type	32-inch Active Matrix WXGA TFT LCD
	Viewing angle	176° (H) / 176° (V)
	Resolution	1366 x 768 (RGB vertical stripe)
	Color	16.7 million
Audio/Video Input Terminals	<ul style="list-style-type: none"> • VGA (75 ohms, 0.7 Vp-p) + PC audio-in (mini-stereo) H/V separated (TTL) for PC; fh: 30-63 kHz, fv: 50-75 Hz • HDMI 1 and HDMI 2 + RCA (L/R) stereo • TV tuner • YPbPr 1 + RCA (L/R) stereo • Composite 1 and Composite 2 + two RCA (L/R) stereos 	
Audio/Video Output Terminals	<ul style="list-style-type: none"> • RCA (L/R) stereo • SPDIF (optical) 	
Speaker Output	9W (2 channels)	
Image Processor	ATI Xilleon™ 241	
TV System Support	NTSC and ATSC	
TV Compatibility	480i, 480P, 720P, 1080i	
PC Compatibility	Recommended (reduced blanking)	1360 x 768 @ 60 Hz 1366 x 768 @ 60 Hz
	Supported	1280 x 720 @ 60 Hz
	H = 30-63 KHz	1024 x 768 @ 60 Hz
	V = 50-75 Hz	720 x 400 @ 70 Hz 640 x 480 @ 60, 75 Hz
DVD Player	Height	40.6 mm
	Loading mechanism	Slot loading
	Disc diameter	8 or 12 cm
	Video formats	ISO/IEC 11172 MPEG-1, 13818 MPEG-2 and 14496-2 MPEG-4
	Audio formats	Dolby Digital, MPEG-I/II Layer 1/2, PCM, LPCM, WMA and MP3
	Picture format	JPEG
	Disc formats	DVD-Video, DVD-Audio, DVD+RW, DVD+R, DVD-R, DVD-RW, CD-DA, VCD, SVCD, CD-R and CD-RW
Power Voltage	120 VAC, 60 Hz, 3A	
Power Consumption (DC)	On	<190W (blue illumination)
	Off in normal mode	Autowake is enabled: < 23W
	Off in energy saving mode	Autowake is disabled: < 2W
	Power saving mode	Autowake is on: < 6w (amber illumination)
Preset Timing Mode	Pre-adjusted to reduce blanking: 1366 x 768 @ 60 Hz	
Operating Conditions	Temperature	15 to +35°C (humidity < 75%)
	Relative humidity	20 to 90% non-condensing (Ta < 35%)
	Altitude	0 to 2,000 m
Storage Conditions	Temperature	-20 to +60°C (humidity < 35%)
	Relative humidity	10 to 90% non-condensing
	Altitude	0 to 12,000 m
Physical Specifications	Dimensions (W x D x H)	With base: 798 x 230 x 600 mm Without base: 798 x 175 x 556 mm
	Weight (net)	With base: 17 kg Without base: 15.6 kg
Regulations	UL/C-UL and FCC-B	
<p>► NOTES:</p> <ul style="list-style-type: none"> • These product specifications are subject to change without user notification. • Do not set your computer graphics card to exceed the unit's refresh rates; doing so may cause damage to the HDTV. 		

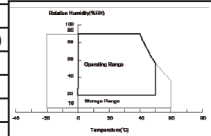

TROUBLESHOOTING

Problem	Corrective Action
No power	<ul style="list-style-type: none"> • Make sure the power indicator is illuminated blue. • Make sure the power cord is securely connected to the AC-in jack and is plugged into a functional AC outlet. You may want to plug in another electrical device to the power outlet to verify that it is supplying the proper voltage.
Power is suddenly turned off	Press ⏻ and select <i>Settings Sleep Timer</i> to make sure the Leave TV On option is selected.
Forgotten PIN	<ol style="list-style-type: none"> (1) Press ⏻ and select <i>Settings Reset All</i>, and then Yes. (2) Access the setup screen again and select Locks. (3) Key in and reconfirm your new PIN.
Remote control does not work	<ul style="list-style-type: none"> • Press only one button at a time. • Make sure the batteries are properly inserted. • The batteries may already be drained out. Replace batteries with new ones.
Remote control code cannot be detected by a universal remote	<ul style="list-style-type: none"> • Purchase a separate learning remote control. • Go to www.wde.com for a list of remote codes.
No picture	<ul style="list-style-type: none"> • Make sure the video input cable is properly connected to the correct terminal, and that the correct input mode is enabled. To illustrate, when a VGA cable is connected to display a computer screen, the PC input mode must be enabled. • In TV mode, verify that the antenna is properly connected and that the preferred channel is enabled in the channel list. Press ⏻ and select <i>Channels Channel List</i>. • Press ⏻ and select <i>Picture</i> to adjust the display settings. • If you are using a Macintosh computer older than a G3 model, you need a Macintosh adapter.
No picture or the <i>No Signal</i> message appears when a VGA cable is connected	<ul style="list-style-type: none"> • Make sure the VGA cable is properly connected to the LCD TV's VGA port. • Decrease the video resolution setting on the computer and try again. • Press ⏻ and select <i>Picture</i> to adjust the display settings. • Press ⏻ and select <i>Settings PC/VGA</i> to adjust the VGA settings. • Decrease the video resolution setting on the computer and try again.
Picture is cut off or appear in a sidebar screen	<ul style="list-style-type: none"> • Press ⏻ and make sure the Standard option is selected. • In PC mode, press ⏻ and select <i>Settings PC/VGA</i>, and then adjust the Horizontal and Vertical settings.
Poor image quality in TV mode (cutoff picture, snowy images)	<ul style="list-style-type: none"> • Check your antenna connection. If necessary, rotate the antenna and wait up to ten seconds for a signal. • Reduce signal splitters and excessively long cables. • Replace poor antenna cables and/or connectors to improve signal quality. • Press ⏻ and make sure the Standard option is selected. • Press ⏻ and select <i>Picture Advanced</i>, and then adjust the Noise Reduction setting. • In HDMI mode, make sure the external device is compatible with the LCD TV.
Wrong, abnormal or missing colors	<ul style="list-style-type: none"> • If any colors (red, green or blue) are missing, check the video cable to make sure it is securely connected. Loose or broken pins in the cable connector could cause an improper connection. • Press ⏻ and select <i>Picture Settings</i> to adjust the Hue and Saturation settings. You can also select <i>Picture Advanced</i> to adjust the Color Temperature settings. • Connect the TV to another computer and check if the problem is with the computer screen.
No sound	<ul style="list-style-type: none"> • Make sure the audio input cable is properly connected to the correct terminal, and that the correct input mode is enabled. • The volume may be muted, press ⏻ or the Vol+ key to turn on the volume on. • Press ⏻ and select <i>Audio</i> to adjust the Bass, Treble, and Balance settings. • If you are using the TV speakers, press ⏻ and select <i>Audio</i> to make sure the TV Speakers option is set to On. • If you are using an external audio device, press ⏻ and select <i>Audio</i> to make sure the TV Speakers option is set to Off. After which, make sure volume on the external audio device is turned on.
<i>No Disc</i> appears on-screen or file playback won't start	<ul style="list-style-type: none"> • Make sure that a disc is loaded and that the disc and file formats are supported by the LCD TV. Go to page 59 for list of compatible disc and file formats. • Make sure the DVD input mode is selected. • The disc may be loaded improperly. Press ▲ and reload the disc making sure the label side is facing upward. • The disc may be dirty. Press ▲ and clean the disc. Go to page 7 for information on how to clean and handle optical discs.
Video file has no picture/sound	<ul style="list-style-type: none"> • Some DVD contents may not be compatible with your LCD TV and can not be accessed. • Make sure the DVD Locks setting is not conflict with the DVD content you wish to access.
No subtitle	During DVD playback, press DVD on the remote control and make sure the preferred subtitle option is selected. Note that some DVD titles may not have subtitles encoded in them.
<p>► NOTE:</p> <p>If the problem condition persists even after performing the recommended corrective actions, contact us by:</p> <ul style="list-style-type: none"> • Logging on to www.wde.com • Contacting the Westinghouse Customer Service at (866) 287-5555 or e-mail us at service@wde.com 	

APPENDIX A - LCD TV BASE REMOVAL

If you intend to repack the LCD TV unit (for shipping or storage) or you want to change the installation to a wall mount option, you must first remove the LCD TV base.

IMPORTANT:

The LCD TV has VESA FPMPMI compliant 100 x 100 mm and 75 x 75 mm mounting holes. Be sure to follow the operating instructions supplied with the wall mount bracket when installing the unit. It is recommended that you employ qualified contractors for wall mount installation.

- (1) Eject any disc loaded in the disc slot.
- (2) Turn off the LCD TV and all connected devices.
- (3) Disconnect the power cord from the LCD TV.
- (4) Disconnect all signal cables from the I/O port terminals.
- (5) Lay the LCD TV on a clear, flat, and stable surface.

CAUTION:

The LCD TV unit maybe too heavy for one person to lift. If this is the case, make sure to ask assistance in handling the LCD TV to prevent physical injury and/or damage to the unit.

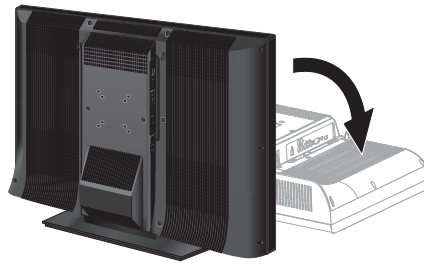

- (6) Remove the four screws securing the base to the LCD TV.
- (7) Detach the base from LCD TV.

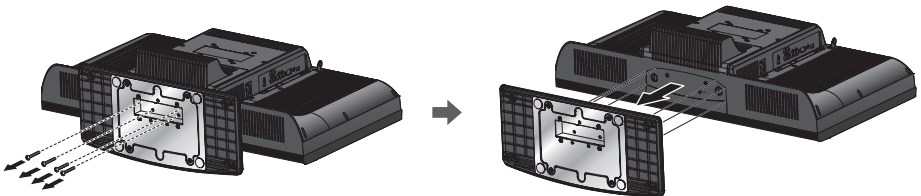

- (8) Pack the screws you removed in step 7 together with the LCD TV base for future reassembly.

APPENDIX B - SAFETY BRACKETS

You can use the safety brackets located on the LCD TV's spine module cover to protect the unit from accidentally tipping over or from unwanted theft.

English

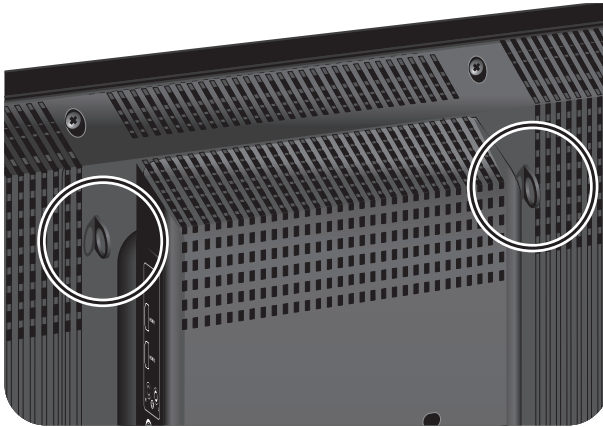

1. ANTI-TIPPING MECHANISM

You can use the safety brackets to anchor the LCD TV in place by looping a security cable through the brackets and securing it to a surface that is strong enough to support the weight of the unit. Using the safety brackets in this manner does not preclude the use of the LCD TV base. **The safety brackets must be used in conjunction with the unit base.** The brackets are only to be used as an additional safety option.

2. ANTI-THEFT PROTECTION

The safety brackets can also be used to protect the LCD TV from unwanted theft by looping a security cable through the brackets and bolting it to an immovable surface.

APPENDIX C - WALL MOUNT OPTION

The LCD TV has been fitted with two sets of VESA FPMPMI compliant mounting holes. These 100 x 100 mm and 75 x 75 mm mounting holes allow the unit to be mounted on a wall.

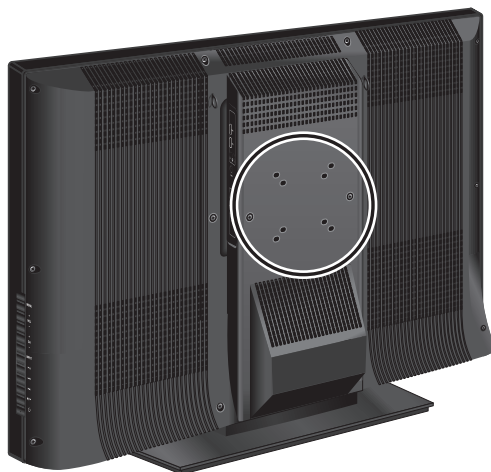

English

IMPORTANT:

Remove the LCD TV base first before mounting the unit on a wall. Go to page 63 for related instructions. It is the user's responsibility to use a UL listed wall mount unit rated to support the weight of this LCD TV. Please consult qualified contractors for wall mount installation. The incomplete or improper mounting of this unit to a wall may cause it to fall down resulting to property damage and/or potentially serious injury.